

SONY[®]

4-145-850-11(1)

Multi Channel AV Receiver

Operating Instructions
STR-DA5500ES



Printed in Malaysia

<http://www.sony.net/>

©2009 Sony Corporation

WARNING

To reduce the risk of fire or electric shock, do not expose this apparatus to rain or moisture.

To reduce the risk of fire, do not cover the ventilation opening of the apparatus with newspapers, tablecloths, curtains, etc. Do not place the naked flame sources such as lighted candles on the apparatus.

Do not install the appliance in a confined space, such as a bookcase or built-in cabinet.

To reduce the risk of fire or electric shock, do not expose this apparatus to dripping or splashing, and do not place objects filled with liquids, such as vases, on the apparatus.

As the main plug is used to disconnect the unit from the mains, connect the unit to an easily accessible AC outlet. Should you notice an abnormality in the unit, disconnect the main plug from the AC outlet immediately.

Do not expose batteries or apparatus with battery-installed to excessive heat such as sunshine, fire or the like.

The unit is not disconnected from the mains as long as it is connected to the AC outlet, even if the unit itself has been turned off.

Excessive sound pressure from earphones and headphones can cause hearing loss.



This symbol is intended to alert the user to the presence of the Hot Surface that may be hot if it is touched during the normal operation.

This equipment has been tested and found to comply with the limits set out in the EMC Directive using a connection cable shorter than 3 meters.

For customers in the United States and Canada



This symbol is intended to alert the user to the presence of uninsulated “dangerous voltage” within the product’s enclosure that may be of sufficient magnitude to constitute a risk of electric shock to persons.



This symbol is intended to alert the user to the presence of important operating and maintenance (servicing) instructions in the literature accompanying the appliance.

For customers in the United States

Owner’s Record

The model and serial numbers are located on the rear of the unit. Record these numbers in the space provided below. Refer to them whenever you call upon your Sony dealer regarding this product.

Model No. _____ Serial No. _____

Important Safety Instructions

- 1) Read these instructions.
- 2) Keep these instructions.
- 3) Heed all warnings.
- 4) Follow all instructions.
- 5) Do not use this apparatus near water.
- 6) Clean only with dry cloth.
- 7) Do not block any ventilation openings. Install in accordance with the manufacturer’s instructions.
- 8) Do not install near any heat sources such as radiators, heat registers, stoves, or other apparatus (including amplifiers) that produce heat.
- 9) Do not defeat the safety purpose of the polarized or grounding-type plug. A polarized plug has two blades with one wider than the other. A grounding type plug has two blades and a third grounding prong. The wide blade or the third prong are provided for your safety. If the provided plug does not fit into your outlet, consult an electrician for replacement of the obsolete outlet.
- 10) Protect the power cord from being walked on or pinched particularly at plugs, convenience receptacles, and the point where they exit from the apparatus.
- 11) Only use attachments/accessories specified by the manufacturer.

- 12) Use only with the cart, stand, tripod, bracket, or table specified by the manufacturer, or sold with the apparatus. When a cart is used, use caution when moving the cart/apparatus combination to avoid injury from tip-over.



- 13) Unplug this apparatus during lightning storms or when unused for long periods of time.
- 14) Refer all servicing to qualified service personnel. Servicing is required when the apparatus has been damaged in any way, such as power-supply cord or plug is damaged, liquid has been spilled or objects have fallen into the apparatus, the apparatus has been exposed to rain or moisture, does not operate normally, or has been dropped.

To reduce the risk of electric shock, the speaker cord should be connected to the apparatus and the speakers in accordance with the following instructions.

- 1) Disconnect the AC power cord from the MAINS.
- 2) Strip 10 to 15 mm of the wire insulation of the speaker cord.
- 3) Connect the speaker cord to the apparatus and the speakers carefully so as not to touch the core of speaker cord by hand. Also disconnect the AC power cord from the MAINS before disconnecting the speaker cord from the apparatus and the speakers.

The following FCC statement applies only to the version of this model manufactured for sale in the U.S.A. Other versions may not comply with FCC technical regulations.

NOTE:

This equipment has been tested and found to comply with the limits for a Class B digital device, pursuant to Part 15 of the FCC Rules. These limits are designed to provide reasonable protection against harmful interference in a residential installation. This equipment generates, uses and can radiate radio frequency energy and, if not installed and used in accordance with the instructions, may cause harmful interference to radio communications. However, there is no guarantee that interference will not occur in a particular installation. If this equipment does

cause harmful interference to radio or television reception, which can be determined by turning the equipment off and on, the user is encouraged to try to correct the interference by one or more of the following measures:

- Reorient or relocate the receiving antenna.
- Increase the separation between the equipment and receiver.
- Connect the equipment into an outlet on a circuit different from that to which the receiver is connected.
- Consult the dealer or an experienced radio/TV technician for help.

CAUTION

You are cautioned that any changes or modifications not expressly approved in this manual could void your authority to operate this equipment.

For customers in Europe

Notice for the customers: the following information is only applicable to equipment sold in countries applying EU directives

The manufacturer of this product is Sony Corporation, 1-7-1 Konan Minato-ku, Tokyo, 108-0075 Japan. The Authorized Representative for EMC and product safety is Sony Deutschland GmbH, Hedelfinger Strasse 61, 70327 Stuttgart, Germany. For any service or guarantee matters, please refer to the addresses given in separate service or guarantee documents.



Disposal of Old Electrical & Electronic Equipment (Applicable in the European Union and other European countries with separate collection systems)

This symbol on the product or on its packaging indicates that this product shall not be treated as household waste. Instead it shall be handed over to the applicable collection point for the recycling of electrical and electronic equipment. By ensuring this product is disposed of correctly, you will help prevent potential negative consequences for the environment and human health, which could otherwise be caused by inappropriate waste handling of this product. The recycling of materials will help to conserve natural resources. For more detailed information about recycling of this product, please contact your local

continued

Civic Office, your household waste disposal service or the shop where you purchased the product.



Disposal of waste batteries (applicable in the European Union and other European countries with separate collection systems)

This symbol on the battery or on the packaging indicates that the battery provided with this product shall not be treated as household waste. On certain batteries this symbol might be used in combination with a chemical symbol. The chemical symbols for mercury (Hg) or lead (Pb) are added if the battery contains more than 0.0005% mercury or 0.004% lead. By ensuring these batteries are disposed of correctly, you will help prevent potentially negative consequences for the environment and human health which could otherwise be caused by inappropriate waste handling of the battery. The recycling of the materials will help to conserve natural resources. In case of products that for safety, performance or data integrity reasons require a permanent connection with an incorporated battery, this battery should be replaced by qualified service staff only. To ensure that the battery will be treated properly, hand over the product at end-of-life to the applicable collection point for the recycling of electrical and electronic equipment. For all other batteries, please view the section on how to remove the battery from the product safely. Hand the battery over to the applicable collection point for the recycling of waste batteries. For more detailed information about recycling of this product or battery, please contact your local Civic Office, your household waste disposal service or the shop where you purchased the product.

About This Manual

- The instructions in this manual are for model STR-DA5500ES (the receiver). Check your model number by looking at the lower right corner of the front panel.
- In this manual, the USA/Canadian model is used for illustration purpose unless stated otherwise. Any differences in operation are clearly indicated in the text, for example, “European model only.”
- The instructions in this manual describe mostly the controls on the supplied simple remote. You can also use the controls on the receiver if they have the same or similar names as those on the remote.

On Copyrights

This receiver incorporates Dolby* Digital and Pro Logic Surround and the DTS** Digital Surround System.

* Manufactured under license from Dolby Laboratories.

Dolby and the double-D symbol are trademarks of Dolby Laboratories.

** Manufactured under license under U.S. Patent #s: 5,451,942; 5,956,674; 5,974,380; 5,978,762; 6,226,616; 6,487,535; 7,212,872; 7,333,929; 7,392,195; 7,272,567 & other U.S. and worldwide patents issued & pending. DTS is a registered trademark and the DTS logos, Symbol, DTS-HD and DTS-HD Master Audio are trademarks of DTS, Inc. © 1996-2008 DTS, Inc. All Rights Reserved.

“Neural-THX” and “neural THX” introduced in the Operating Instructions and displayed in the display window and on the GUI menu screen mean Neural-THX Surround.

This product using Neural-THX[®] Surround is manufactured under license from Neural Audio Corporation and THX Ltd. Sony Corporation hereby grants the user a non-exclusive, non-transferable, limited right of use to this product under USA and foreign patent, patent pending and other technology or trademarks owned by Neural Audio Corporation and THX Ltd. “Neural Surround”, “Neural Audio”, “Neural” and “NRL” are trademarks and logos owned by Neural Audio Corporation, THX is a trademark of THX Ltd., which may be registered in some jurisdictions. All rights reserved.

This receiver incorporates High-Definition Multimedia Interface (HDMI™) technology.

HDMI, the HDMI logo and High-Definition Multimedia Interface are trademarks or registered trademarks of HDMI Licensing LLC.

SIRIUS, XM and all related marks and logos are trademarks of Sirius XM Radio Inc. and its subsidiaries. All rights reserved. Service not available in Alaska and Hawaii.

The font type (Shin Go R) installed in this receiver is provided by MORISAWA & COMPANY LTD. These names are the trademarks of MORISAWA & COMPANY LTD., and the copyright of the font also belongs to MORISAWA & COMPANY LTD.

iPod is a trademark of Apple Inc., registered in the U.S. and other countries. All other trademarks and registered trademarks are of their respective holders. In this manual, ™ and © marks are not specified.

The Bluetooth word mark and logos are owned by the Bluetooth SIG, Inc. and any use of such marks by Sony Corporation is under license. Other trademarks and trade names are those of their respective owners.

“BRAVIA” Sync is a trademark of Sony Corporation.

DLNA and DLNA CERTIFIED are trademarks and/or service marks of the Digital Living Network Alliance.

VAIO is a trademark of Sony Corporation.

Microsoft, Windows, Windows Vista, and Windows Media are trademarks or registered trademarks of Microsoft Corporation in the United States and/or other countries.

Intel, Intel Core, and Pentium are trademarks or registered trademarks of Intel Corporation or its subsidiaries in the United States and other countries.

Rhapsody & the Rhapsody logo are trademarks and/or registered trademarks of RealNetworks, Inc.

SHOUTcast® is a registered trademark of AOL LLC.

THIS PRODUCT IS LICENSED UNDER THE VC-1 PATENT PORTFOLIO LICENSE FOR THE PERSONAL AND NON-COMMERCIAL USE OF A CONSUMER TO

(i) ENCODE VIDEO IN COMPLIANCE WITH THE VC-1 STANDARD (“VC-1 VIDEO”) AND/OR
(ii) DECODE VC-1 VIDEO THAT WAS ENCODED BY A CONSUMER ENGAGED IN A PERSONAL AND NON-COMMERCIAL ACTIVITY AND/OR WAS OBTAINED FROM A VIDEO PROVIDER LICENSED TO PROVIDE VC-1 VIDEO.

NO LICENSE IS GRANTED OR SHALL BE IMPLIED FOR ANY OTHER USE. ADDITIONAL INFORMATION MAY BE OBTAINED FROM MPEG LA, L.L.C. SEE [HTTP://WWW.MPEGLA.COM](http://WWW.MPEGLA.COM)

MPEG Layer-3 audio coding technology and patents licensed from Fraunhofer IIS and Thomson.

“x.v.Color (x.v.Colour)” and “x.v.Color (x.v.Colour)” logo are trademarks of Sony Corporation.

This product incorporates copyright protection technology that is protected by U.S. patents and other intellectual property rights.

Use of this copyright protection technology must be authorized by Macrovision, and is intended for home and other limited viewing uses only unless otherwise authorized by Macrovision. Reverse engineering or disassembly is prohibited.

Table of Contents

Description and location of parts8

Getting Started

1: Installing speakers	21
2: Connecting the monitor	25
3a: Connecting the audio components	27
3b: Connecting the video components	32
3c: Connecting the IR Blaster	42
4: Connecting the antennas (aerials)	44
5: Connecting to the network	45
6: Preparing the receiver and the remote	47
7: Setting the speakers	48
8: Calibrating the appropriate speaker settings automatically (Auto Calibration)	50
9: Configuring the network settings of the receiver	57
10: Preparing a computer to use as a server	58
Guide to on-screen display operation	59

Playback

Enjoying sound/images from the component connected to the receiver	62
Enjoying sound/images from the components connected to the DIGITAL MEDIA PORT	64
Operating the TDM-iP50 using the GUI menu of the receiver	65

Tuning

Listening to FM/AM radio	68
Presetting FM/AM radio stations	71
Listening to satellite radio (USA/Canadian model only)	73
Connecting a satellite radio tuner	74
Preparing to listen to a satellite radio	74
Selecting a channel of the satellite radio	75
Presetting satellite radio channels	77

Restricting access to specific channels (Parental Lock) (SIRIUS only)	78
--	----

Enjoying Surround Sound

Playing back with 2-channel sound	82
Playing back with multi-channel surround	83
Enjoying a surround effect for music	86
Enjoying a surround effect for movies	88

Using Network Features

About the network functions of the receiver	92
What you can do with the home network function	93
Enjoying content stored on the server	96
Listening to Rhapsody	98
Listening to SHOUTcast	101
Features of the ES Utility application software	103

Using Multi-zone Features

What you can do with the Multi-zone function	105
Making a multi-zone connection	106
Setting the speakers in zone 2	108
Switching the zone setting of the remote	109
Operating the receiver from another zone (ZONE 2/ZONE 3 operations)	109
Listening to the same music in different zone (Party Mode)	110

Using Other Features

Using “BRAVIA” Sync features	112
Switching the monitors that output the HDMI video signals	116
Outputting the HDMI signals even when the receiver is in standby mode (Pass Through)	116
Switching between digital and analog audio	117
Enjoying the sound/images from other inputs (Input Assign)	118
Using the sleep timer	121
Enjoying the surround effect at low volume levels	122
Recording using the receiver	123
Switching the command mode of the receiver and the remote	124
Using a bi-amplifier connection	126

Adjusting Settings

Using the setting menu	127
Auto Calibration	128
Speaker settings	130
Surround settings	134
EQ settings	136
Multi Zone settings	136
Audio settings	138
Video settings	140
HDMI settings	142
Network settings	144
Quick Click settings	145
System settings	146
Operating without connecting to a TV	147

Operating Each Component Using the On-screen Remote (Quick Click)

Operating components or lighting connected to the receiver using the on-screen remote (Quick Click)	153
Using Quick Click	154

Setting components that are operated by the on-screen remote	160
Performing several commands in sequence automatically with Quick Click (Macro Play)	165
Setting remote control codes that are not stored in Quick Click	167
Resetting the remote code for Quick Click	168

Operating Each Component Using the Multifunction Remote

Operating each component using the multifunction remote	170
Programming the remote	172
Performing several commands in sequence automatically (Macro Play)	175
Setting remote commander codes that are not stored in the remote	177
Clearing all the contents of the remote’s memory	179

Additional Information

Glossary	180
Precautions	184
Troubleshooting	185
Specifications	192
Index	195

Description and location of parts

Front panel

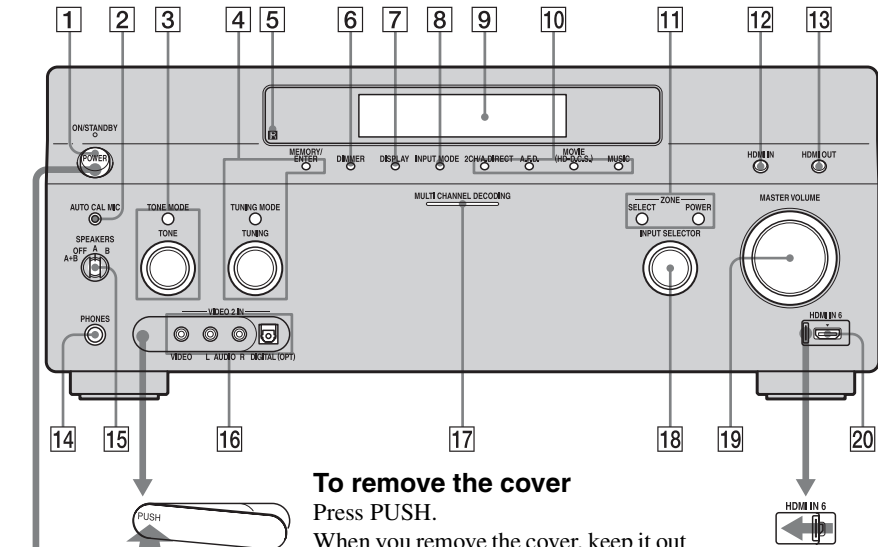

To remove the cover

Press PUSH.

When you remove the cover, keep it out of reach from children.

To open the cover

Slide the cover to the left.

Status of the POWER button

Off

The receiver is turned off (initial setting).

Press POWER to turn the receiver on. You cannot turn the receiver on using the remote.

On/Standby

Press I/O on the remote to turn the receiver on or set it to the standby mode. When you press POWER on the receiver, the receiver will be turned off.

Name	Function
1 POWER	Press to turn the receiver on or off.
2 AUTO CAL MIC jack	Connects to the supplied optimizer microphone for the Digital Cinema Auto Calibration function (page 51).
3 TONE MODE TONE	Adjusts FRONT, CENTER, SURROUND/ SURROUND BACK BASS and TREBLE. Press TONE MODE repeatedly to select BASS or TREBLE, then turn TONE to adjust the level.
4 MEMORY/ ENTER TUNING MODE TUNING	Press to operate a tuner (FM/AM) and satellite radio (XM/SIRIUS) (USA/Canadian model only).
5 Remote sensor	Receives signals from remote commander.
6 DIMMER	Press repeatedly to adjust brightness of the display.
7 DISPLAY	Press repeatedly to select information displayed on the display.
8 INPUT MODE	Press to select the input mode when the same components are connected to both digital and analog jacks (page 117).
9 Display window	The current status of the selected component or a list of selectable items appears here (page 11).

Name	Function
10 2CH/A.DIRECT A.F.D. MOVIE (HD-D.C.S.) MUSIC	Press to select sound field (page 82, 83, 86, 88).
11 ZONE/ SELECT, POWER	Press SELECT repeatedly to select zone 2, zone 3 or main zone. Each time you press POWER, the output signals for the selected zone will be turned on or off (page 105).
12 HDMI IN	Press to select the input signal from the component connected to the HDMI IN jacks (page 33).
13 HDMI OUT	Press to select output signal to the component connected to the HDMI OUT jacks (page 33).
14 PHONES jack	Connects to headphones.
15 SPEAKERS (OFF/A/B/A+B)	Switch to OFF, A, B, A+B of the front speakers (page 50).
16 VIDEO 2 IN jacks	Connect to a portable audio/video component such as a camcorder or video game.
17 MULTI CHANNEL DECODING lamp	Lights up when multi-channel audio signals are decoded.

Name	Function
18 INPUT SELECTOR	Turn to select the input source to play back. To select the input source for zone 2 or zone 3, press ZONE SELECT (11) to select zone 2 or zone 3 first (“ZONE 2 INPUT” or “ZONE 3 INPUT” appears on the display), then turn INPUT SELECTOR to select the input source.
19 MASTER VOLUME	Turn to adjust the volume level of all speakers at the same time.
20 HDMI IN 6	Connect to a camcorder. The video and sound from your camcorder is input (page 33).

Indicators on the display

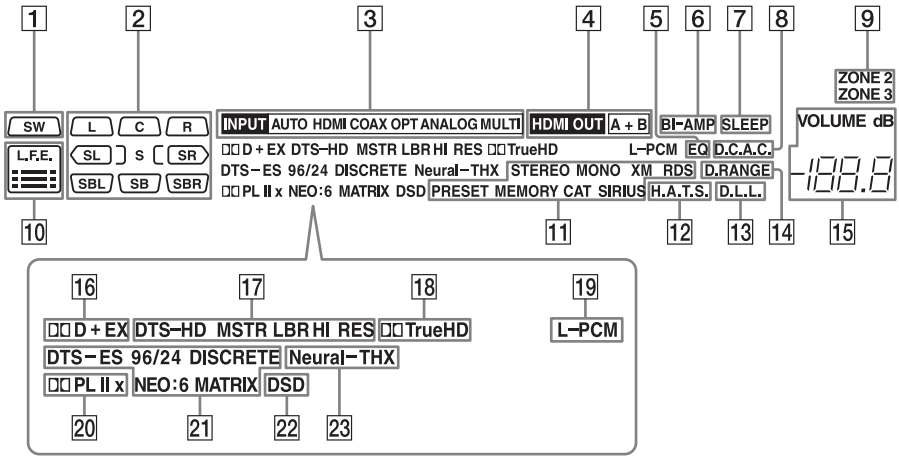



Name	Function
1 SW	Lights up when subwoofer is connected and the audio signal is output from the SUBWOOFER jack. While this indicator lights up, the receiver creates a subwoofer signal based on the L.F.E. signal in the disc being played back or the low frequency components of the front channels.



Name	Function
2 Playback channel indicators	The letters (L, C, R, etc.) indicate the channels being played back. The boxes around the letters vary to show how the receiver downmixes the source sound (based on the speaker settings).
L	Front Left
R	Front Right
C	Center (monaural)
SL	Surround Left
SR	Surround Right
S	Surround (monaural or the surround components obtained by Pro Logic processing)
SBL	Surround Back Left
SBR	Surround Back Right
SB	Surround Back (the surround back components obtained by 6.1 channel decoding)
	Example: Recording format (Front/Surround): 3/2.1 Output channel: Surround speakers are set to "NO." Sound Field: A.F.D. AUTO
	

Name	Function
3 Input indicators	Light up to indicate the current input.
INPUT	Lights up constantly with either following the corresponding indicators that indicate the current input status.
AUTO	Lights up with the corresponding indicators that indicate the current input when INPUT MODE is set to "Auto."
HDMI	The receiver recognizes a component connected via an HDMI IN jack.
COAX	Digital signal is input through the COAXIAL jack.
OPT	Digital signal is input through the OPTICAL jack.
ANALOG	No digital signal is being input. When INPUT MODE is set to "Analog," or when the "2ch Analog Direct" is being selected, it also lights up.
MULTI	The multi-channel input is selected.
4 HDMI OUT A + B	Lights up when the signals are output from the HDMI OUT A or B jack. + also lights up, along with A and B when the signals are output from both jacks.
5 EQ	Lights up when the equalizer is activated.
6 BI-AMP	Lights up when surround back speakers selection is set to "BI-AMP."
7 SLEEP	Lights up when the sleep timer is activated.

Name	Function
8 D.C.A.C.	Lights up when auto calibration is activated.
9 ZONE 2/ ZONE 3	Lights up while operation in zone 2/zone 3 is being enabled.
10 L.F.E.	Lights up when the disc being played back contains an L.F.E. (Low Frequency Effects) channel. The L.F.E. channel signal is actually being reproduced, the bars underneath the letters light up to indicate the level. Since the L.F.E. signal is not recorded in all parts of the input signal, the bar indication will fluctuate (and may turn off) during playback.

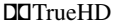
Name	Function
11 Tuning indicators	Lights up when the receiver tunes in radio stations, or satellite radio stations.
STEREO	Stereo broadcast
MONO	Monaural broadcast
XM (USA/ Canadian model only)	The XM Mini-Tuner and Home Dock are connected and “XM” is selected.
SIRIUS (USA/ Canadian model only)	The SiriusConnect Home tuner is connected and “SIRIUS” is selected.
CAT (USA/ Canadian model only)	The category mode is selected during the satellite radio operation.
RDS (European model only)	RDS information is received.
PRESET	The tuning mode is set to the preset mode.
MEMORY	A memory function, such as Name Input, etc., is activated.
12 H.A.T.S.	Lights up when the H.A.T.S. (High quality digital Audio Transmission System) function is activated.
13 D.L.L.	Lights up when the D.L.L. (Digital Legato Linear) function is activated.
14 D.RANGE	Lights up when dynamic range compression is activated.
15 VOLUME	Displays the current volume.

Name	Function
16 Dolby Digital Surround indicators	Lights up one of the respective indicators when the receiver is decoding the corresponding Dolby Digital format signals.
	Dolby Digital
	Dolby Digital Plus
	Dolby Digital Surround EX
	Note When playing a Dolby Digital format disc, be sure that you have made digital connections and that INPUT MODE is not set to "Analog."
17 DTS-HD indicators	Light up when the receiver is decoding DTS-HD.
DTS-HD	Lights up constantly with the one of the following indicators.
MSTR	DTS-HD Master Audio
LBR	DTS-HD Low Bit Rate Audio
HI RES	DTS-HD High Resolution Audio
18 	Lights up when the receiver is decoding Dolby TrueHD.
19 L-PCM	Lights up when Linear PCM (Pulse Code Modulation) signals are input.

Name	Function
20 Dolby Pro Logic indicators	Lights up one of the respective indicators when the receiver performs Dolby Pro Logic processing. This matrix surround decoding technology can enhance input signals.
	Dolby Pro Logic
	Dolby Pro Logic II
	Dolby Pro Logic IIx
	Note This indicator does not light when either the center speaker and surround speaker is not connected.
21 DTS(-ES) indicators	Light up when DTS or DTS-ES signals are input.
DTS	Lights up when the receiver is decoding DTS signals. Either 96/24 or NEO:6 also lights up depending on the input signal format or decoding format.
96/24	DTS 96/24 (96 kHz/24 bit) decoding
NEO:6	DTS Neo:6 Cinema/Music
DTS-ES	Lights up with the either following indicator depending on the input signal decoding format.
DISCRETE	DTS-ES Discrete 6.1
MATRIX	DTS-ES Matrix 6.1
	Note When playing a DTS format disc, be sure that you have made digital connections and that INPUT MODE is not set to "Analog."
22 DSD	Lights up when the receiver is receiving DSD (Direct Stream Digital) signals.
23 Neural-THX	Lights up when the receiver applies Neural-THX processing to input signals.

Rear panel

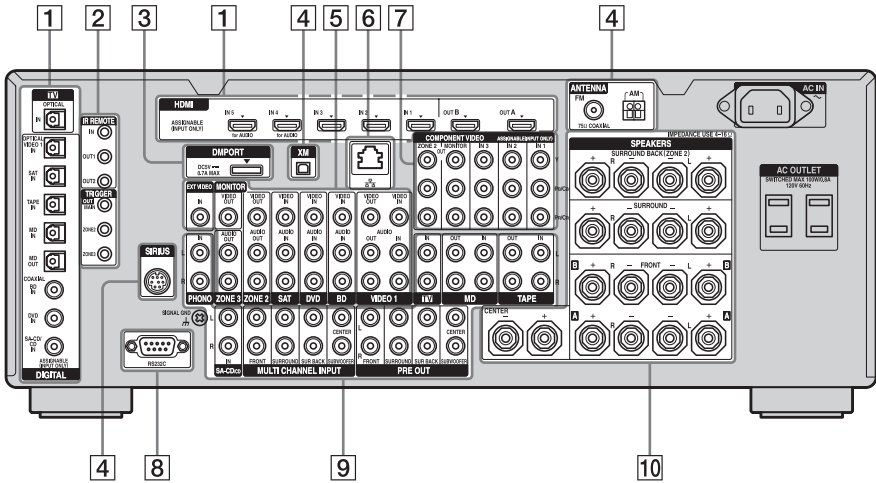

1 DIGITAL INPUT/OUTPUT section



OPTICAL IN/OUT jacks Connect to a DVD player, Super Audio CD player, etc. (page 25, 28, 34, 37, 38).



COAXIAL IN jacks



HDMI IN/OUT* jacks Connect to a DVD player, Blu-ray Disc Player, or a satellite tuner. An image and the sound are output to TV or a projector (page 25, 33).

2 Control jacks for Sony equipment and other external components



IR REMOTE IN/OUT jacks Connect an IR repeater (page 105) or an IR Blaster (page 42).



TRIGGER OUT jacks Connect to interlock on/off of the power supply of other 12V TRIGGER compliant components, or the amplifier/receiver of zone 2 or zone 3 (page 137).

3 DMPORT



Connect to a Sony DIGITAL MEDIA PORT adapter (page 28).

4 ANTENNA section



FM ANTENNA jack Connects to the FM wire antenna (aerial) supplied with this receiver (page 44).



AM ANTENNA jack Connects to the AM loop antenna (aerial) supplied with this receiver (page 44).



XM jack (USA/Canadian model only) Connects to the XM Mini-Tuner and Home Dock (not supplied) (page 74).



SIRIUS jack (USA/Canadian model only) Connects to a SiriusConnect Home tuner (not supplied) (page 74).

continued

5 VIDEO/AUDIO INPUT/OUTPUT section

 AUDIO IN/OUT jacks Connect to a VCR or a DVD player etc. (page 25, 37, 38, 39).

 VIDEO IN/OUT* jacks

 AUDIO OUT jacks Connect to the component in zone 2 or zone 3 (page 105).
VIDEO OUT jack



 EXT VIDEO IN jack Connects to the component when you want to watch in PIP (Picture in Picture) window.

6 LAN port



Connects to the router when you want to connect the receiver to your network.

7 COMPONENT VIDEO INPUT/OUTPUT section

 Y, P_B/C_B, P_R/C_R IN/OUT* jacks Connect to a DVD player, TV, or a satellite tuner (page 25, 37, 38).

8 RS232C port



Used for maintenance and service.

9 AUDIO INPUT/OUTPUT section

 AUDIO IN/OUT jacks Connect to a tape deck or MD deck, etc (page 31).

 MULTI CHANNEL INPUT jacks Connect to a Super Audio CD player or DVD player with an analog audio jack for 7.1 channel or 5.1 channel sound (page 30).

 PRE OUT jacks Connect to an external power amplifier.

10 SPEAKERS section



Connects to speakers (page 23).

* You can watch the selected input image when you connect the HDMI OUT or MONITOR OUT jacks to a TV (page 25).

Remote commander



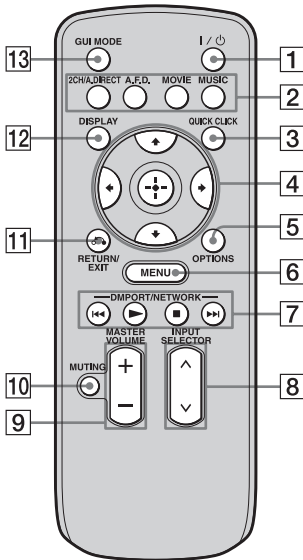

You can use the supplied remote to operate the receiver and to control the Sony audio/video components that the remote is assigned to operate.

Simple remote commander (RM-AAU061)

This remote can only be used to operate the receiver. You can control the main functions of the receiver with simple operations using this remote.



Name	Function
1 I/⏻ (on/standby)	Press to turn a receiver on or off.
2 2CH/A.DIRECT A.F.D. MOVIE MUSIC	Press to select sound field (page 82, 83, 86, 88).

Name	Function
3 QUICK CLICK	Press to display the on-screen remote on the TV screen.
4  ↑/↓/←/→	Press ↑/↓/←/→ to select the menu item. Then press ⊕ to enter the selection.
5 OPTIONS	Press to display and select items from option menus.
6 MENU	Press to display the menu to operate the receiver.
7 DMPORT/ NETWORK	Press to operate the component connected to the DIGITAL MEDIA PORT adapter (page 64), or to play back content on the server (page 97).
	Starts play.
	Stops play.
	Skips tracks.
8 INPUT SELECTOR	Press to select the input source to play back.
9 MASTER VOLUME +/-	Press to adjust the volume level.
10 MUTING	Press to turn off the sound temporarily. Press the button again to restore the sound.
11 RETURN/EXIT 	Press to return to the previous menu or exit the menu.
12 DISPLAY	Press to display the current status of or information on components connected to the receiver. Note In the GUI MODE, press the button to display the menu on the TV screen.
13 GUI MODE	Press to switch the display mode of the menu between GUI MODE (to display the menu on the TV screen) and DISPLAY MODE (to display the menu in the display window).

continued

Multifunction remote commander (RM-AAL021/RM-AAL022)

The RM-AAL021 remote is supplied with the European model only and RM-AAL022 is supplied with the USA/Canadian model only. The RM-AAL022 remote is used for illustration purpose. Any differences in operation are clearly indicated in the text, for example, “USA/Canadian model only.”

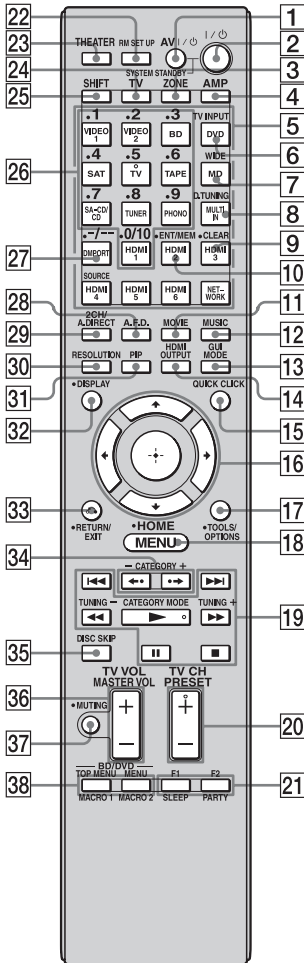

Name	Function
1 AV I/O (on/standby)	Press to turn on or off the audio/video components that the remote is assigned to operate (page 172). If you press I/O (2) button at the same time, it will turn off the receiver and other Sony components (SYSTEM STANDBY). Note The function of the AV I/O switch changes automatically each time you press the input button (5).
2 I/O (on/standby)	Press to turn the receiver on or off. If zone 2 or zone 3 is selected, only the main receiver is turned on or off with this button. To turn off all components including an amplifier in zone 2 or zone 3, press I/O and AV I/O (1) at the same time (SYSTEM STANDBY).
3 ZONE	Press to switch the zone 2 or zone 3 operation (page 105).
4 AMP	Press to enable the receiver operation.
5 Input buttons	Press one of the buttons to select the component you want to use. When you press any of the input buttons, the receiver turns on. The buttons are factory assigned to control Sony components (page 62). You can program the remote to control non-Sony components following the steps in “Programming the remote” (page 172).
6 TV INPUT	Press TV (24), then press TV INPUT to select the input signal of a TV.

Name	Function
7 WIDE	Press TV (24), then press WIDE repeatedly to select the wide picture mode.
8 D.TUNING	Press SHIFT (25), then press to enter direct tuning mode (page 69, 76).
9 CLEAR	Press SHIFT (25), then press to <ul style="list-style-type: none"> – clear a mistake when you press the incorrect numeric button. – return to continuous playback, etc. of the satellite tuner or DVD player.
10 ENT/MEM	Press SHIFT (25), then press ENT/MEM to enter the value after selecting a channel, disc, or track using the numeric buttons, or to store a station during tuner operation.
11 MOVIE	Press to select sound field for movies (page 88).
12 MUSIC	Press to select sound field for music (page 86).
13 GUI MODE	Press to switch the display mode of the menu between GUI MODE (to display the menu on the TV screen) and DISPLAY MODE (to display the menu in the display window).
14 HDMI OUTPUT	Press to select an HDMI jack you want to output HDMI video signals to (page 33).
15 QUICK CLICK	Press to display the on-screen remote on the TV screen.
16	 <p>Press ▲/▼/◀/▶ to select the menu items. Then press ⊕ to enter the selection.</p>
17 TOOLS/ OPTIONS	Press to display and select items from option menus for receiver, DVD player, TV, or Blu-ray Disc Player, etc.
18 MENU HOME	Press to display the menu used to operate audio/video components or a TV.

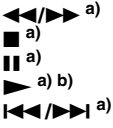
Name	Function
19	 <p>Press to operate the DVD player, Blu-ray Disc Player, CD player, MD deck, tape deck, or component connected to the DIGITAL MEDIA PORT adapter etc.</p>
CATEGORY MODE	Press to select the category mode for satellite tuner. (USA/ Canadian model only)
TUNING +/-	Press to select station.
20 PRESET + b)/-	Press to register FM/AM/ satellite tuner stations or to select preset stations.
TV CH + b)/-	Press TV (24), then press TV CH +/- to operate the TV, satellite tuner, VCR, etc.
21 F1/F2	Press BD or DVD (5), then press F1 or F2 to select a component to operate. <ul style="list-style-type: none"> • HDD/DISC combo F1: HDD F2: DVD disc, Blu-ray Disc • DVD/VHS combo F1: DVD disc, Blu-ray Disc F2: VHS
PARTY	Press to display confirmation screen to start party mode (page 110).
SLEEP	Press AMP (4), then press SLEEP to activate the sleep timer function and the duration which the receiver turns off automatically (page 121).
22 RM SET UP	Press to set up the remote (page 124).
23 THEATER	Press to turn the Theater mode on and off when connecting the receiver to products featuring “BRAVIA” Sync.
24 TV	Press to enable the TV operation.
25 SHIFT	Press to light up the button. It changes the remote button function to activate the buttons with pink printing.

continued

Name	Function
26 Numeric buttons	Press SHIFT (25), then press to <ul style="list-style-type: none"> – preset/tune to preset stations. – select track numbers of the CD player, DVD player, Blu-ray Disc Player or MD deck. Press +/- (27) to select track number 10. – select channel numbers of the VCR or satellite tuner. – After pressing TV (24), press the numeric buttons to select the TV channels.
27 -/+	Press to <ul style="list-style-type: none"> – select track numbers over 10 of the CD player, DVD player, Blu-ray Disc Player, or MD deck. – select channel numbers over 10 of the TV, Satellite tuner or the VCR.
28 A.F.D.	Press to select sound field (page 83).
29 2CH/ A.DIRECT	Press to select sound field or to switch the audio of the selected input to analog signal without any adjustment (page 82).
30 RESOLUTION	Press RESOLUTION repeatedly to change the resolution of signals output from the HDMI OUT or COMPONENT VIDEO MONITOR OUT jack.
31 PIP	Press PIP to switch the image of the PIP (Picture in Picture) window. The image of the PIP window is the one from the EXT VIDEO IN jack. You can swap the position of the main screen and the PIP window by pressing \oplus (16). Note When the HDMI input is selected on the main screen, you cannot swap the position of the main screen and the PIP window.
32 DISPLAY	Press to display the current status of or information on components connected to the receiver. Note In the GUI MODE, press the button to display the menu on the TV screen.

Name	Function
33 RETURN/ EXIT ↵	Press to return to the previous menu or exit the menu while the menu or on-screen guide of the VCR, DVD player, or satellite tuner is displayed on the TV screen.
34 CATEGORY +/- (USA/ Canadian model only)	Press to select the category for satellite tuner.
↔/↔	Press to select an album.
35 DISC SKIP	Press to skip a disc when using a multi-disc changer.
36 MASTER VOL +/-	Press to adjust the volume level of all speakers at the same time.
TV VOL +/-	Press TV (24), then press TV VOL +/- to adjust the volume level of the TV.
37 MUTING	Press to turn off the sound temporarily. Press the button again to restore the sound.
38 BD/DVD/ TOP MENU, MENU	Press to display the menus of the DVD player on the TV screen. Then use $\uparrow/\downarrow/\leftarrow/\rightarrow$ and \oplus to perform a menu operations.
MACRO1, MACRO2	Press AMP (4), then press MACRO 1 or MACRO 2 to set up the macro function (page 175).

^{a)} See the table on page 171 for information on the buttons that you can use to control each component.

^{b)} The tactile dot is attached to these buttons (TV/5, \blacktriangleright , PRESET +/-TV CH +). Use as a mark of operation.

Notes

- Some functions explained in this section may not work depending on the model.
- The above explanation is intended to serve as an example only. Therefore, depending on the component, the above operation may not be possible or may operate differently than described.

1: Installing speakers

This receiver allows you to use a 7.1 channel system (7 speakers and one subwoofer).

Enjoying a 5.1/7.1 channel system

To fully enjoy theater-like multi-channel surround sound requires five speakers (two front speakers, a center speaker, and two surround speakers) and a subwoofer (5.1 channel system).

Example of a 5.1 channel speaker system configuration

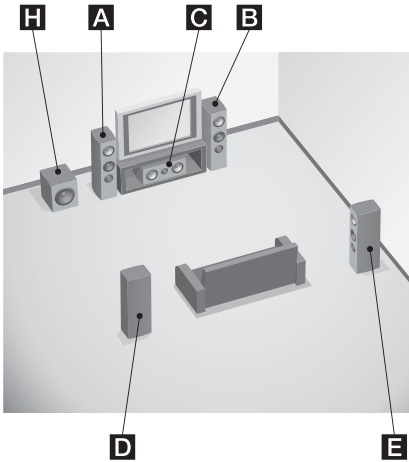

- A** Front left speaker
- B** Front right speaker
- C** Center speaker
- D** Surround left speaker
- E** Surround right speaker
- H** Subwoofer

You can enjoy high fidelity reproduction of DVD or Blu-ray Disc software recorded sound in the Surround EX format if you connect one additional surround back speaker (6.1 channel system) or two surround back speakers (7.1 channel system).

Example of a 7.1 channel speaker system configuration

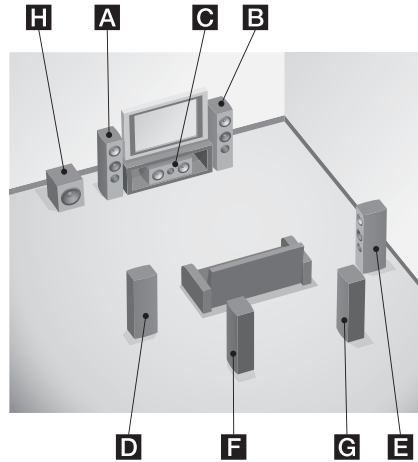

- A** Front left speaker
- B** Front right speaker
- C** Center speaker
- D** Surround left speaker
- E** Surround right speaker
- F** Surround back left speaker
- G** Surround back right speaker
- H** Subwoofer

Tips

- The angle **A** should be the same.

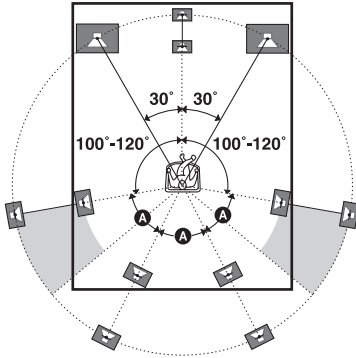

- When you connect a 6.1 channel speaker system, place the surround back speaker behind the seating position.

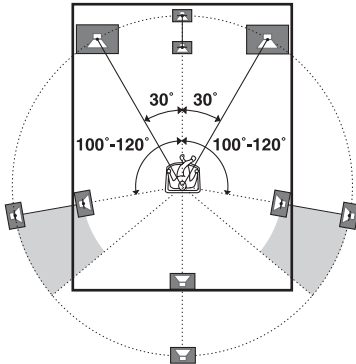

- Since the subwoofer does not emit highly directional signals, you can place it wherever you want.

Connecting speakers

Before connecting cords, make sure to disconnect the AC power cord (mains lead).

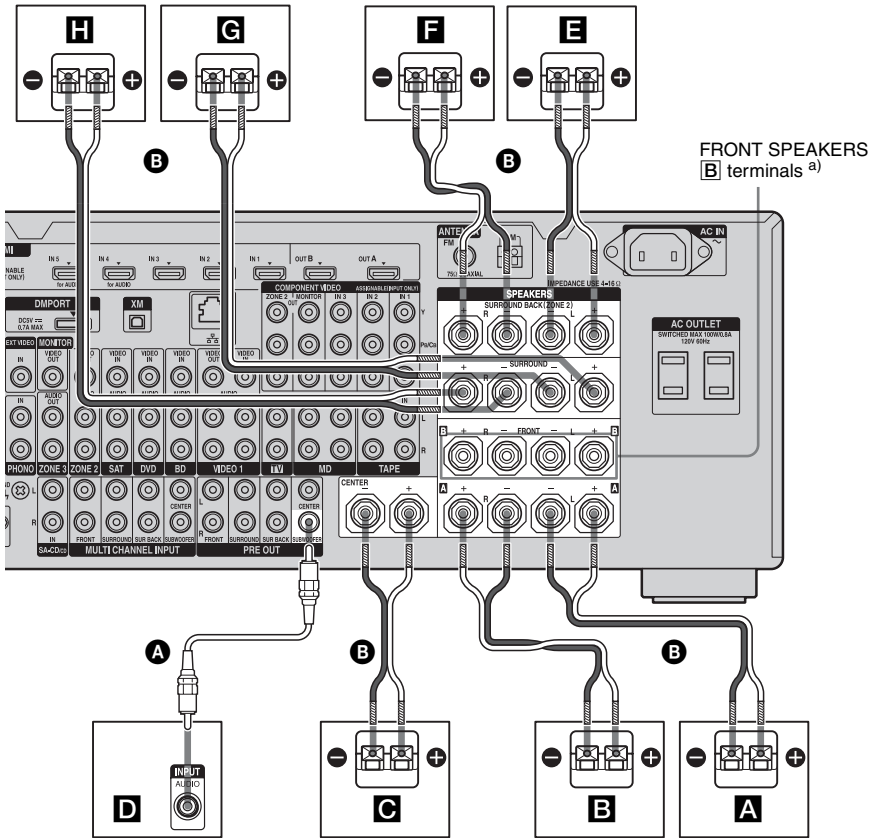

- A** Monaural audio cord (not supplied)
- B** Speaker cords (not supplied)

- A** Front speaker **A** (L)
- B** Front speaker **A** (R)
- C** Center speaker
- D** Subwoofer^{b)}
- E** Surround back speaker (L)^{c)}
- F** Surround back speaker (R)^{c)}
- G** Surround speaker (L)
- H** Surround speaker (R)

^{a)} If you have an additional front speaker system, connect them to the FRONT SPEAKERS **B** terminals. You can select the front speaker system you want to use with the SPEAKERS switch (OFF/A/B/A+B) on the front panel (page 50).

- b) When you connect a subwoofer with an auto standby function, turn off the function when watching movies. If the auto standby function is set to on, it turns to standby mode automatically based on the level of the input signal to a subwoofer, then sound may not be output.
- c) If you connect only one surround back speaker, connect it to the SURROUND BACK SPEAKERS L terminals.

Notes

- When you connect all the speakers with a nominal impedance of 8 ohms or higher, set “Impedance” in the Speaker settings menu to “8 Ω.” In other connections, set it to “4 Ω.” For details, see “7: Setting the speakers” (page 48).
- Before connecting the AC power cord (mains lead), make sure that metallic wires of the speaker cords are not touching each other between the SPEAKERS terminals.

Tip

To connect certain speakers to another power amplifier, use the PRE OUT jacks. The same signal is output from both the SPEAKERS terminals and the PRE OUT jacks. For example, if you want to connect just the front speakers to another amplifier, connect that amplifier to the PRE OUT FRONT L and R jacks.

ZONE 2 connection

You can assign the SURROUND BACK SPEAKERS terminals **E** and **F** to the speakers of the zone 2. Set “Sur Back Assign” to “ZONE2” in the Speaker settings menu. See “Using Multi-zone Features” (page 105) for details on connection and operation in zone 2.

2: Connecting the monitor

You can watch the selected input image when you connect the HDMI OUT or MONITOR OUT jacks to a TV. You can operate this receiver using a GUI (Graphical User Interface). It is not necessary to connect all the cables. Connect audio and video cords according to the jacks of your components.

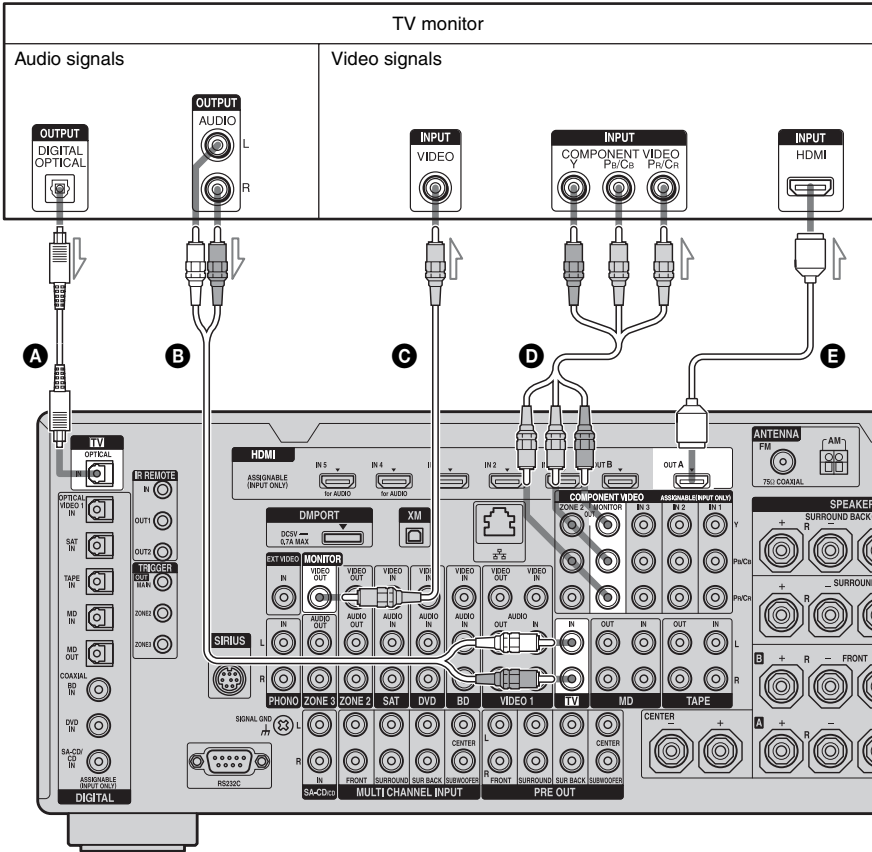

- A** Optical digital cord (not supplied)
- B** Audio cord (not supplied)
- C** Video cord (not supplied)
- D** Component video cord (not supplied)
- E** HDMI cable (not supplied)

Notes

- Before connecting cords, make sure to disconnect the AC power cord (mains lead).
- Connect image display components such as a TV monitor or a projector to the MONITOR VIDEO OUT jack on the receiver. You may not be able to record, even if you connect recording components.
- Turn on the receiver when the video and audio of a playback component are being output to a TV via the receiver. If the power supply of the receiver is not turned on, neither video nor audio is transmitted.
- Depending on the status of the connection between the TV and the antenna (aerial), the image on the TV screen may be distorted. In this case, place the antenna (aerial) farther away from the receiver.

Tips

- The receiver has a video conversion function. For details, see “Notes on converting video signals” (page 41).
- The sound of the TV is output from the speakers connected to the receiver if you connect the audio output jack of the TV and the TV IN jacks of the receiver. In this configuration, set the sound output jack of the TV to “Fixed” if it can be switched between either “Fixed” or “Variable.”
- The screen saver is activated when the GUI menu is displayed on the TV screen and there has been no operation attempted for 15 minutes.

3a: Connecting the audio components

How to hook up your components

This section describes how to hook up your components to this receiver. Before you begin, see “Component to be connected” below for the pages which describe how to connect each component.

After hooking up all your components, proceed to “4: Connecting the antennas (aerials)” (page 44).

Component to be connected		Page
Super Audio CD player/ CD player	With digital audio output	28
	With multi-channel audio output	30
	With analog audio output only	31
MD player	With digital audio output	28
	With analog audio output only	31
Tape deck, Analog disc turntable		31

Connecting components with digital audio input/output jacks

The following illustration shows how to connect a Super Audio CD player, CD player, an MD deck and DIGITAL MEDIA PORT adapter.

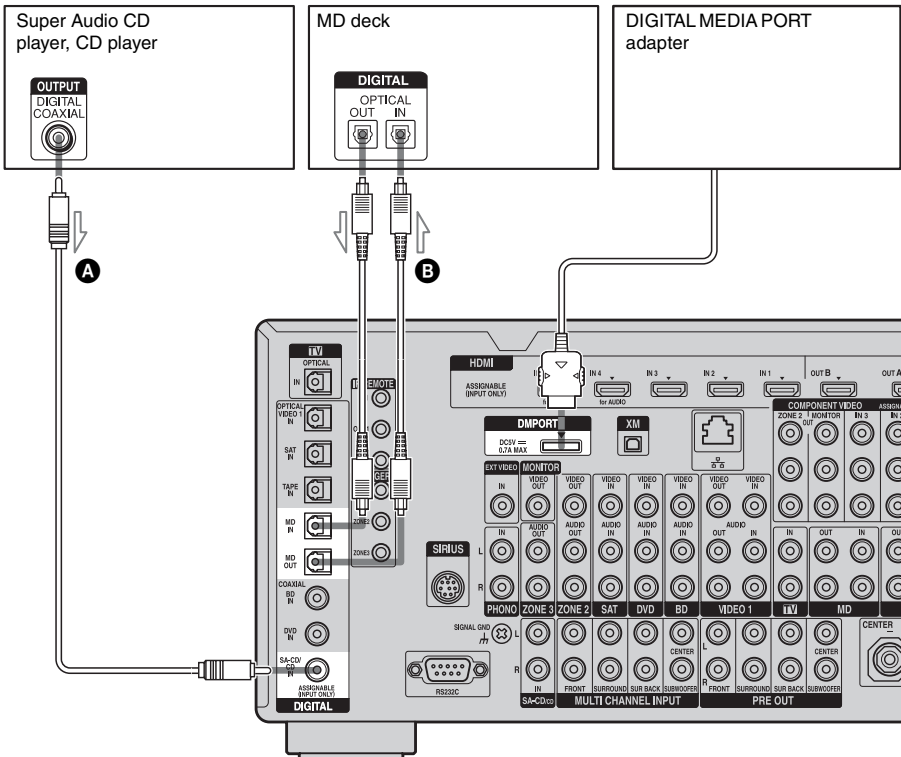

- A** Coaxial digital cord (not supplied)
- B** Optical digital cord (not supplied)

Notes

- When connecting optical digital cords, insert the plugs straight in until they click into place.
- Do not bend or tie optical digital cords.
- Before connecting cords, make sure to disconnect the AC power cord (mains lead).
- To disconnect the DIGITAL MEDIA PORT adapter, observe the following precautions.
 - Remove the DIGITAL MEDIA PORT adapter after removing the cord when cords are connected to the COMPONENT VIDEO jack.
 - Remove the DIGITAL MEDIA PORT adapter by squeezing the sides of the connector, since the connector is locked in place.

Tip

All the digital audio jacks are compatible with 32 kHz, 44.1 kHz, 48 kHz, 88.2 kHz and 96 kHz sampling frequencies.

Notes on playing a Super Audio CD on a Super Audio CD player

- No sound is output when playing a Super Audio CD on a Super Audio CD player connected to only the COAXIAL SA-CD/CD IN jack on this receiver. When you play a Super Audio CD, connect the player to the MULTI CHANNEL INPUT or SA-CD/CD IN jacks. Refer to the operating instructions supplied with the Super Audio CD player.
- Connect a player which can output DSD signals from the HDMI jack to the receiver using an HDMI cable.
- You cannot make digital recordings of a Super Audio CD.

If you want to connect several digital components, but cannot find an unused input

See “Enjoying the sound/images from other inputs (Input Assign)” (page 118).

Connecting components with multi-channel output jacks

If your DVD player, Blu-ray Disc Player or Super Audio CD player is equipped with multi-channel output jacks, you can connect them to the MULTI CHANNEL INPUT jacks of this receiver to enjoy multi-channel sound. Alternatively, the multi-channel input jacks can be used to connect an external multi-channel decoder.

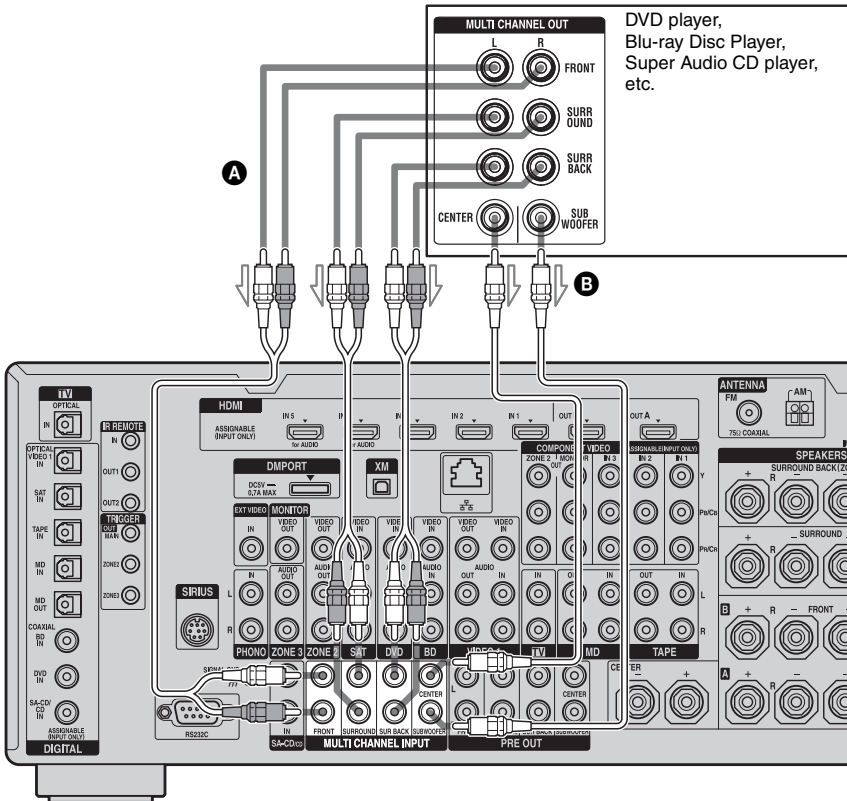

- A** Audio cord (not supplied)
- B** Monaural audio cord (not supplied)

Notes

- Before connecting cords, make sure to disconnect the AC power cord (mains lead).
- DVD player, Blu-ray Disc Player and Super Audio CD players may not have the SURROUND BACK jacks.
- When “Sur Back Assign” is set to “BI-AMP” or “ZONE2” in the Speaker settings menu, the input to the SUR BACK jacks is invalid.

- Audio input signals from MULTI CHANNEL INPUT jacks are not output to any audio output jacks. The signals cannot be recorded.

Connecting components with analog audio jacks

The following illustration shows how to connect a component with analog jacks, such as Super Audio CD, CD player, MD deck, tape deck and turntable, etc.

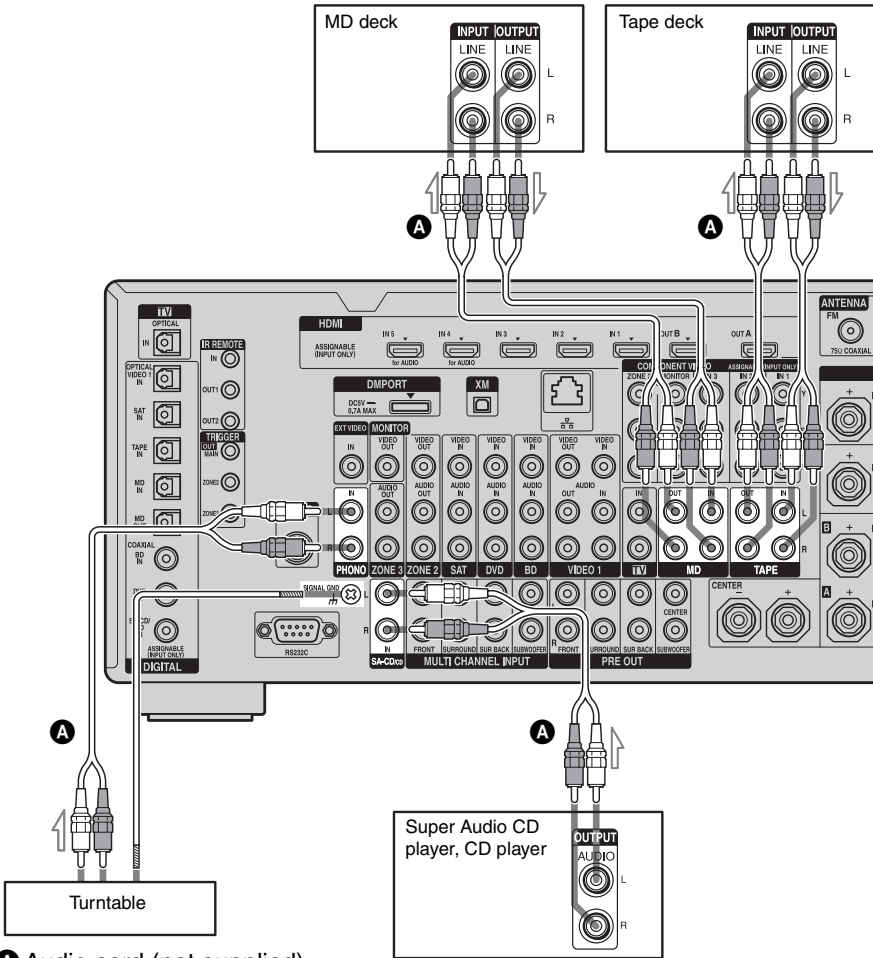

A Audio cord (not supplied)

Notes

- If your turntable has a ground (earth) wire, connect it to the (⌚) SIGNAL GND terminal.
- Before connecting cords, make sure to disconnect the AC power cord (mains lead).

3b: Connecting the video components

How to hook up your components

This section describes how to hook up your components to this receiver. Before you begin, see “Component to be connected” below for the pages which describe how to connect each component.

After hooking up all your components, proceed to “4: Connecting the antennas (aerials)” (page 44).

Component to be connected	Page
TV monitor	25
With HDMI jack	33
DVD player, Blu-ray Disc Player	37
Satellite tuner, Set-top box	38
DVD recorder, VCR	39
Camcorder, video game, etc.	39

Video input/output jacks to be connected

The image quality depends on the connecting jack. See the illustration that follows. Select the connection according to the jacks on your components.

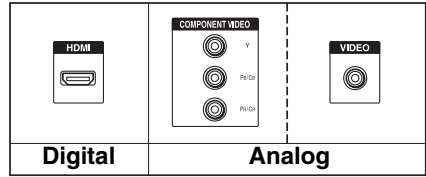

Connecting components with HDMI jacks

HDMI is the abbreviated name for High-Definition Multimedia Interface. It is an interface which transmits video and audio signals in digital format.

HDMI features

- A digital audio signals transmitted by HDMI can be output from the speakers and the PRE OUT jacks on this receiver. This signal supports Dolby Digital, DTS, DSD, and Linear PCM.
- Linear PCM (sampling frequency less than 192 kHz) with digital audio signals of up to 8 channels can be received with this receiver using the HDMI IN jack.
- Analog video signals input to the VIDEO jack, or COMPONENT VIDEO jacks can be output as HDMI signals. Audio signals are not output from HDMI OUT jacks when the image is converted.
- This receiver supports DSD transmission (Super Audio CD), extended by HDMI ver1.2.
- This receiver supports High Bitrate Audio (DTS-HD Master Audio, Dolby TrueHD), Deep Color and x.v.Color (x.v.Colour) transmission, extended by HDMI ver1.3.
- The HDMI jacks of this receiver support the Control for HDMI function. The HDMI OUT B jack, however, does not support the Control for HDMI function.
- HDMI IN 4 and IN 5 are inputs which are considered sound quality. Input IN 4 or IN 5 when you need higher quality sound. You can also use IN 4 or IN 5 jacks in the same manner as the HDMI IN 3.
- The HDMI IN 1, IN 2, and IN 6 jacks are used for connecting a camcorder. Use the HDMI IN 1, IN 2, and IN 6 jacks when you connect a camcorder to the receiver.

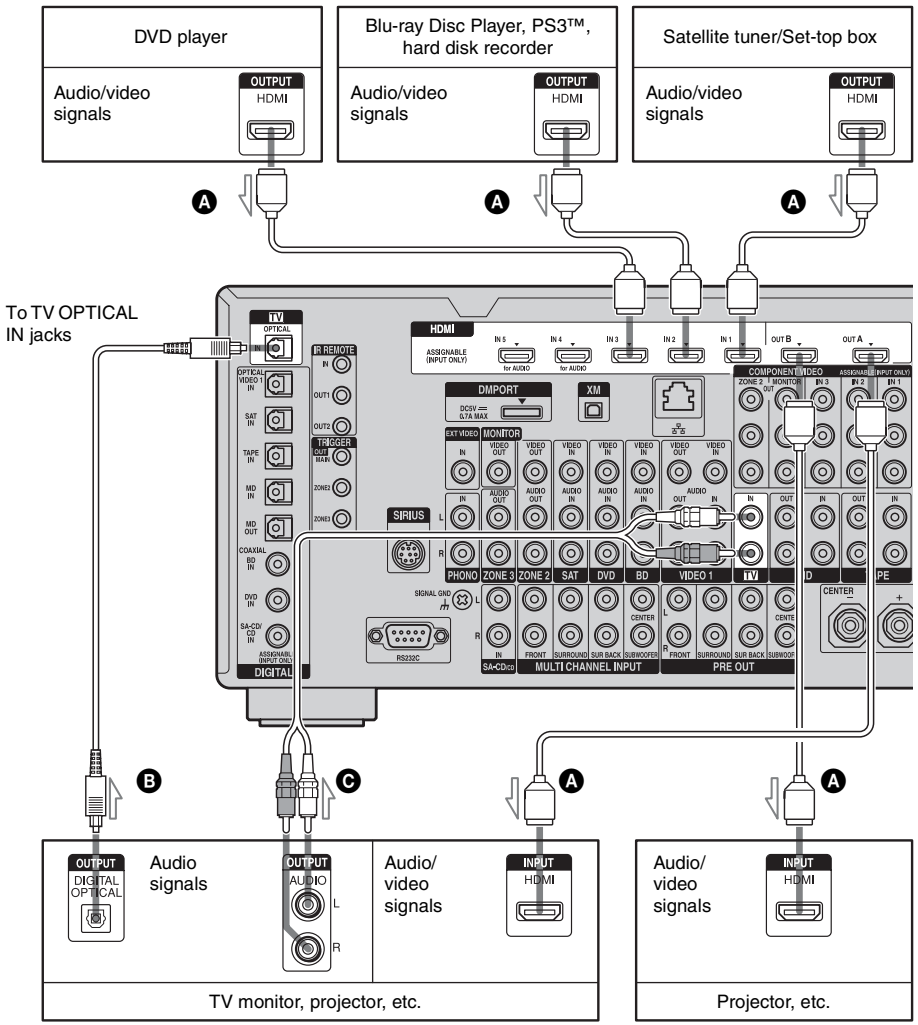

- A** HDMI cable (not supplied)
We recommend that you use a Sony HDMI cable.
- B** Optical digital cord (not supplied)
- C** Audio cord (not supplied)

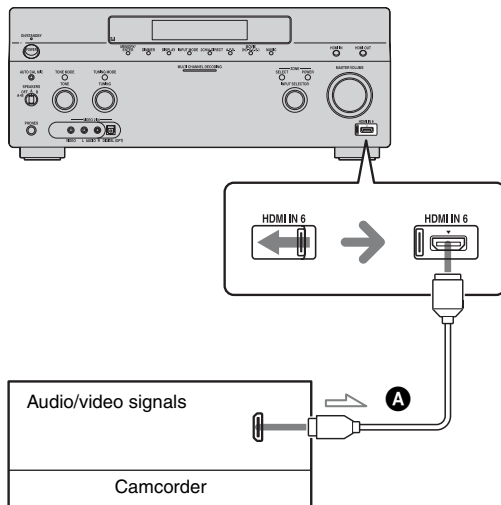

A HDMI cable (not supplied)

We recommend that you use a Sony HDMI cable.

To enjoy TV multi channel surround sound broadcasting

You can listen to TV multi channel surround sound broadcasting from the speakers connected to the receiver.

Connect the OPTICAL output jack of the TV to the OPTICAL IN jack of the receiver.

Tips

- Connect to at least one of the audio cords (**B** or **C**).
- You can watch the image of the camcorder easily with connecting your camcorder to the HDMI IN 1, IN 2, and IN 6 jacks (page 114).

Notes on connecting cables

- Use a High Speed HDMI cable. If you use a Standard HDMI cable, 1080p or Deep Color images may not be displayed properly.
- Sony recommends that you use an HDMI-authorized cable or Sony HDMI cable.
- We do not recommend using an HDMI-DVI conversion cable. When you connect an HDMI-DVI conversion cable to a DVI-D component, the sound and/or the image may not be output. Connect other audio cords or digital connecting cords, then set “Input Assign” in the Input Option menu when the sound is not output correctly.
- Before connecting cables, make sure to disconnect the AC power cord (mains lead).

Notes on HDMI connections

- Check the setup of the connected component if an image is poor or the sound does not come out of a component connected via the HDMI cable.
- An audio signal input to the HDMI IN jack is output from the speaker output jacks, PHONES jack, HDMI OUT jack and PRE OUT jacks. It is not output from any other audio jacks.
- A video signal input to the HDMI IN jack can only be output from the HDMI OUT jack. The video input cannot be output from the VIDEO OUT jacks or MONITOR VIDEO OUT jacks.
- When you want to listen to the sound from the TV speaker, set “Audio Out” to “TV+AMP” in the HDMI settings menu. If set to “AMP,” the sound is not output from the TV speaker.
- Be sure to turn on the receiver when video and audio signals of a playback component are being output to a TV through this receiver. If you set “Pass Through” to “OFF,” unless the power is on, neither video nor audio signals will be transmitted.

- Audio signals (sampling frequency, bit length, etc.) transmitted from an HDMI jack may be suppressed by the connected component. Check the setup of the connected component if an image is poor or the sound does not come out of a component connected via the HDMI cable.
- Sound may be interrupted when the sampling frequency, the number of channels or audio format of audio output signals from the playback component is switched.
- When the connected component is not compatible with copyright protection technology (HDCP), the image and/or the sound from the HDMI OUT jack may be distorted or may not be output. In this case, check the specification of the connected component.
- Refer to the operating instructions of each component connected for details.
- Set the image resolution of the player to more than 720p/1080i to enjoy High Bitrate Audio (DTS-HD Master Audio, Dolby TrueHD).
- The image resolution of player may need certain settings be made before you can enjoy DSD and multi-channel Linear PCM. Refer to the operating instructions of the player.
- Not every HDMI component supports all functions that are defined by the specified HDMI version. For example, components that support HDMI, ver. 1.3a, may not support Deep Color.

Connecting a DVD player, Blu-ray Disc Player

The following illustration shows how to connect a DVD player, Blu-ray Disc Player. It is not necessary to connect all the cables. Connect audio and video cords according to the jacks of your components.

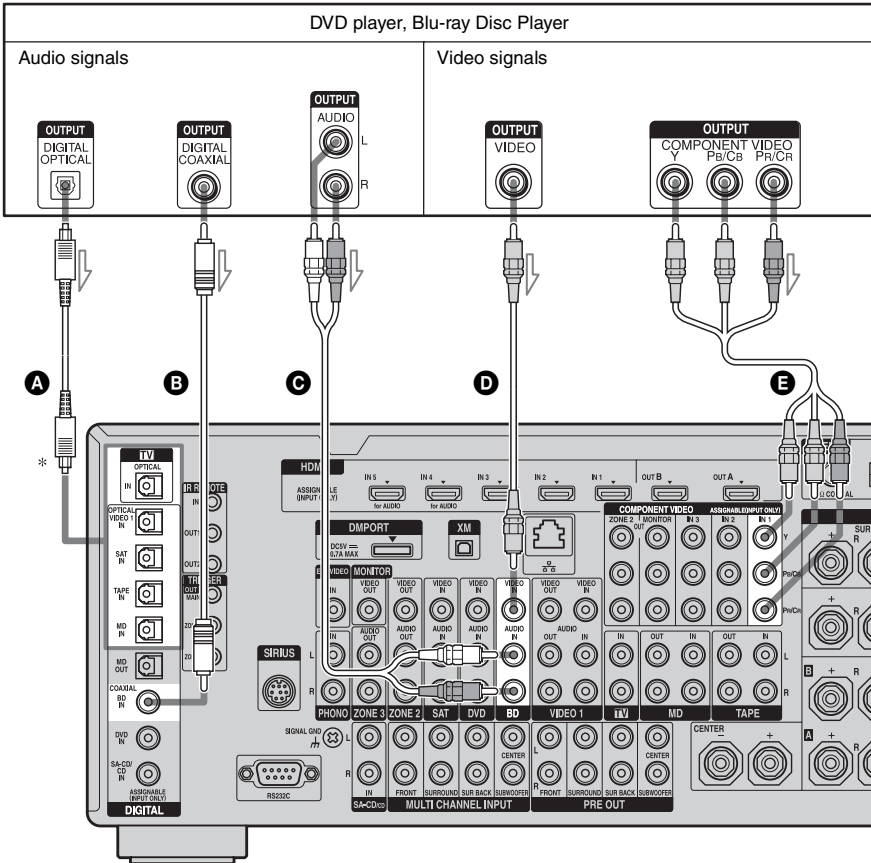

- A** Optical digital cord (not supplied)
- B** Coaxial digital cord (not supplied)
- C** Audio cord (not supplied)

- D** Video cord (not supplied)
- E** Component video cord (not supplied)

* When you connect a component equipped with an OPTICAL jack, set "Input Assign" in the Input menu.

Notes

- To output multi-channel digital audio, set the digital audio output setting on the DVD player, Blu-ray Disc Player. Refer to the operating instructions supplied with the DVD player, Blu-ray Disc Player.
- Before connecting cords, make sure to disconnect the AC power cord (mains lead).

Connecting a satellite tuner, Set-top box

The following illustration shows how to connect a satellite tuner, Set-top box.

It is not necessary to connect all the cables. Connect audio and video cords according to the jacks of your components.

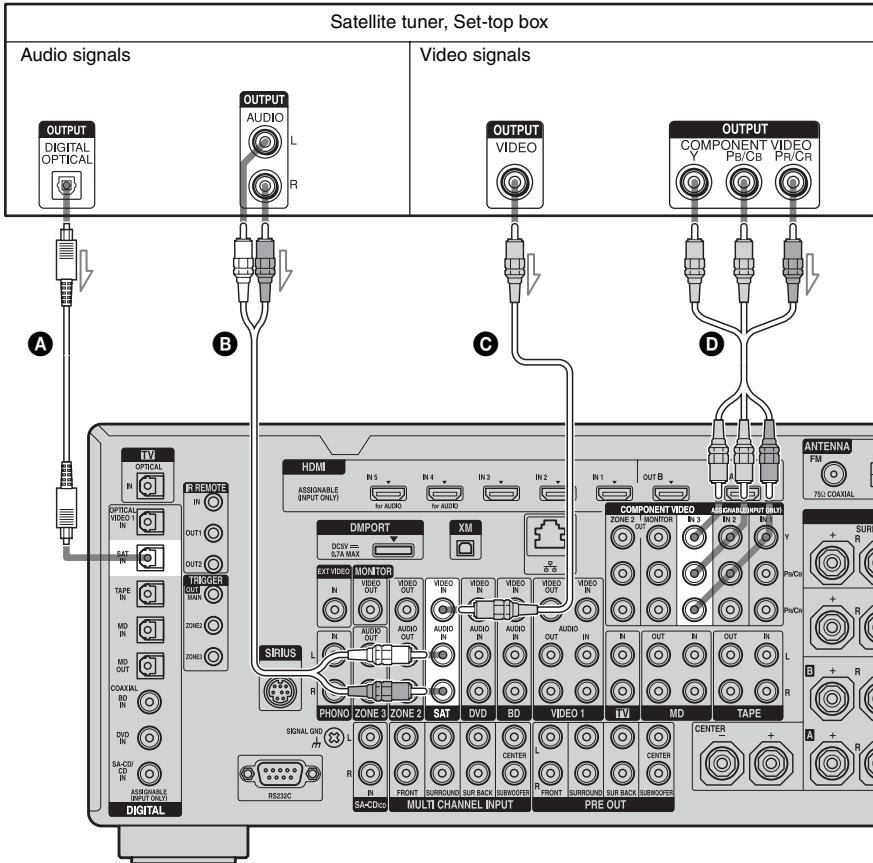

- A** Optical digital cord (not supplied)
- B** Audio cord (not supplied)
- C** Video cord (not supplied)
- D** Component video cord (not supplied)

Note

Before connecting cords, make sure to disconnect the AC power cord (mains lead).

Connecting components with analog video and audio jack

The following illustration shows how to connect a component which has analog jacks such as a DVD recorder or VCR, etc.

It is not necessary to connect all the cables. Connect audio and video cords according to the jacks of your components.

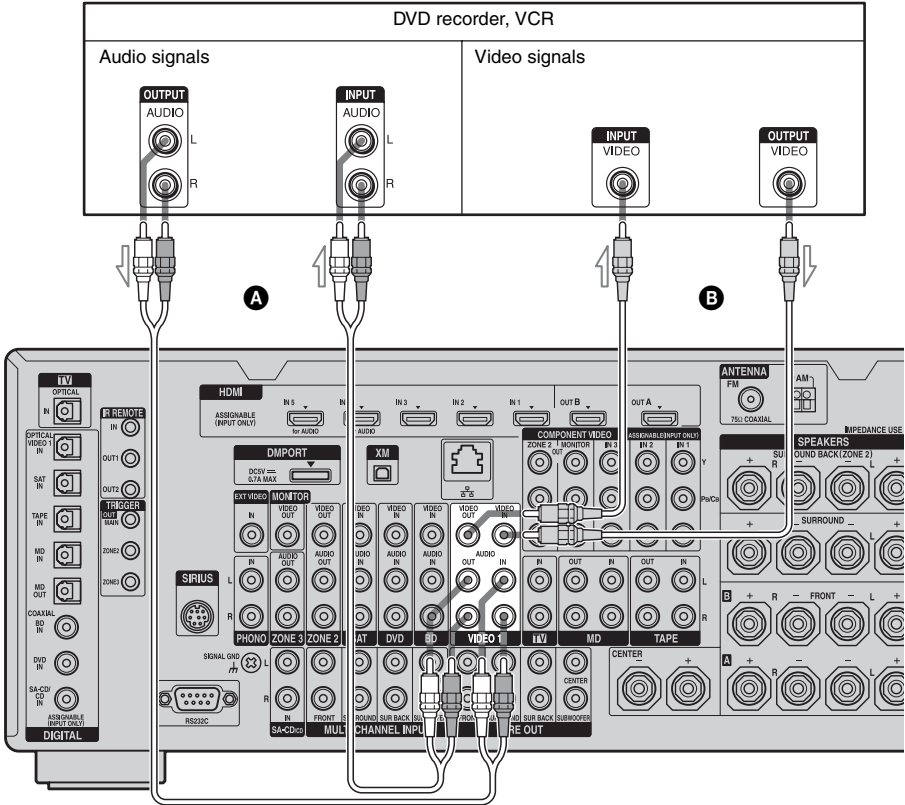

- A** Audio cord (not supplied)
- B** Video cord (not supplied)

continued

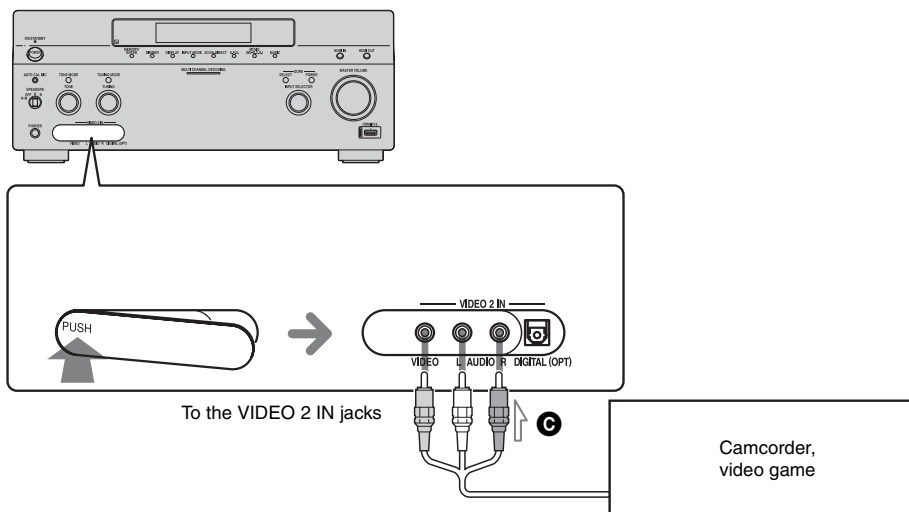

Ⓢ Audio/video cord (not supplied)

Note

Before connecting cords, make sure to disconnect the AC power cord (mains lead).

Function for conversion of video signals

This receiver is equipped with a function for converting video signals.

- Composite video signals can be output as HDMI video and component video signals.
- Component video signals can be output as HDMI video and video signals.

As the initial setting, video signals input from the connected component are output to the HDMI OUT or MONITOR OUT jacks as shown in the table below.

We recommend you set the video conversion function to match the resolution of the monitor you are using.

For details on the video converting function, see “ Video settings” (page 140).

INPUT jack \ OUTPUT jack	HDMI OUT A/B	COMPONENT VIDEO MONITOR OUT	MONITOR VIDEO OUT
HDMI IN 1/2/3/4/5/6	○	—	—
VIDEO IN	○	○	○
COMPONENT VIDEO IN	○	○	○

○ : Video signals are output.

— : Video signals are not output.

Notes on converting video signals

- When video signals from a VCR, etc., are converted on this receiver and then output to your TV, depending on the status of the video signal output, the image on the TV screen may appear distorted horizontally or no image may be output.
- HDMI video signals cannot be converted to component video signals and video signals.
- The converted video signals are not output from the VIDEO OUT jack.
- When you play a VCR with an image improvement circuit, such as TBC, the images may be distorted or may not be output. In this case, set the image improvement circuit function to off.
- The resolution of the signals output to the COMPONENT VIDEO MONITOR OUT jacks is converted up to 1080i. The resolution of the signals output to the HDMI OUT jacks are converted up to 1080p.
- COMPONENT VIDEO MONITOR OUT jacks have restrictions on resolution when the resolution of video signals protected by copyright technology is converted. Resolution of up to 480p can be output to the COMPONENT VIDEO MONITOR OUT jacks. The HDMI OUT jacks have no restriction on resolution.
- Video signals for which the resolution has been converted cannot be output from either the COMPONENT VIDEO MONITOR OUT jacks or the HDMI OUT jacks. The video signals are output from the HDMI OUT jacks when both are connected.
- Set “Resolution” to “AUTO” or “480i/576i” in the Video settings menu to output the video signals from the MONITOR VIDEO OUT, COMPONENT VIDEO MONITOR OUT jacks when both are connected.

To display Closed Caption

Set “Resolution” to “DIRECT” in the Video settings menu when receiving a signal that supports Closed Captions.

Use the same kind of cords for the input/output signals.

To connect a recording component

When recording, connect the recording component to the VIDEO OUT jacks of the receiver. Connect cords for input and output signals to the same type of jack, as VIDEO OUT jacks do not have an up-conversion function.

Note

Signals output from the HDMI OUT or MONITOR OUT jacks may not be recorded properly.

3c: Connecting the IR Blaster

Attach the supplied IR Blaster to components connected to the receiver. You can control components connected to the receiver via the IR Blaster using the on-screen remote control.

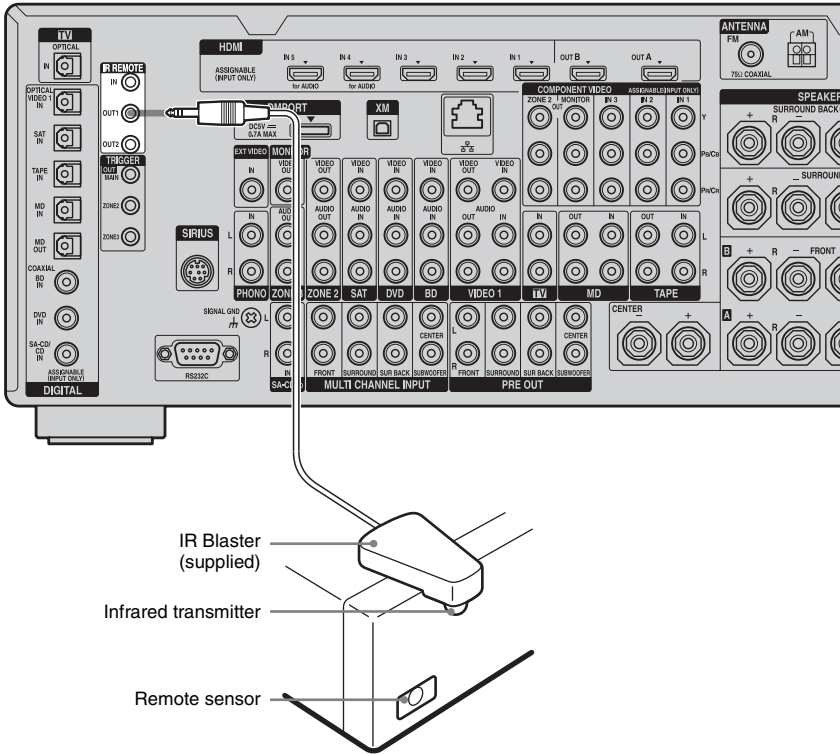

Place the components and the IR Blaster as follows when you want to operate two components with the IR Blaster.

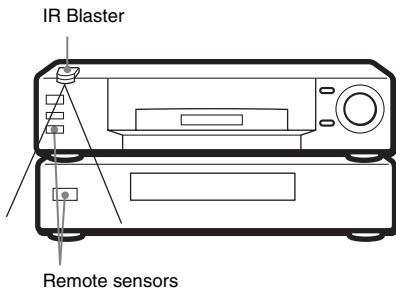

If the infrared receivers on the two components do not line up as shown in the illustration on the left, you must purchase an optional IR Blaster (VM-50, not supplied) and install it.

Note

For details on how to set up a component, refer to the operating instructions of the component.

Tip

If the IR Blaster cable is too short, use a 3.5 mm jack extension cable (not supplied).

After referring to the operating instructions of the components connected to the receiver, make sure to place the IR Blaster just above or below the remote sensor. Remote sensors on Sony Recorders and other products are identified by the  symbol.

Note

Do not remove the backing paper from the IR Blaster yet.

After configuring the settings, remove the backing paper from the IR Blaster and fix it in place.

4: Connecting the antennas (aerials)

Connect the supplied AM loop antenna (aerial) and FM wire antenna (aerial).

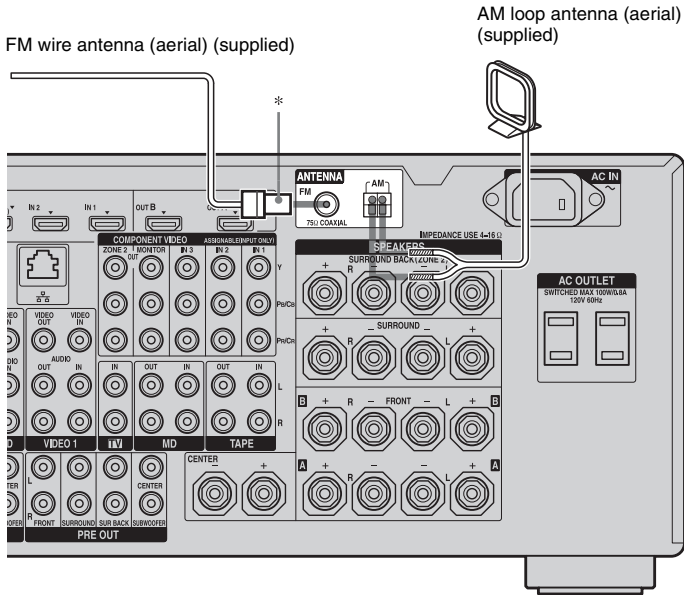

* The shape of the connector varies depending on the area.

Notes

- To prevent noise pickup, keep the AM loop antenna (aerial) away from the receiver and other components.
- Be sure to fully extend the FM wire antenna (aerial).
- After connecting the FM wire antenna (aerial), keep it as horizontal as possible.
- Before connecting cords, make sure to disconnect the AC power cord (mains lead).

5: Connecting to the network

Configuring your home network with DLNA-compliant devices.

If your computer is connected to the Internet, you can connect this receiver to the Internet as well, through the wired LAN connection.

Note

The method used to connect your computer to the Internet depends on the devices, your ISP, your computer, and the router used.

System requirements

The following system environment is required to use the network function of the receiver.

A Broadband line connection

A Broadband line connection to the Internet is required in order to listen to Rhapsody® or SHOUTcast and to use the firmware update function of the receiver. Rhapsody is only available in the US.

Modem

This is the device that is connected to the broadband line to communicate with the Internet. Some of these devices are integrated with the router.

Router

- Use a router compatible with 100 Mbps or greater transmission speeds to enjoy content on your home network.
- We recommend that you use a router equipped with the built-in DHCP (Dynamic Host Configuration Protocol) server. This function automatically assigns IP addresses on the LAN.

LAN cable (CAT-5)

- We recommend that you use this type of cable for a wired LAN. Some flat-type LAN cables are easily affected by noise. We recommend that you use normal-type cables.

- If the receiver is used in an environment in which there is power supply noise from electric products or in a noisy network environment, use a shielded-type LAN cable.

Configuration example

The following illustration is a configuration example of a home network with the receiver, a computer.

We recommend that you use a wired connection.

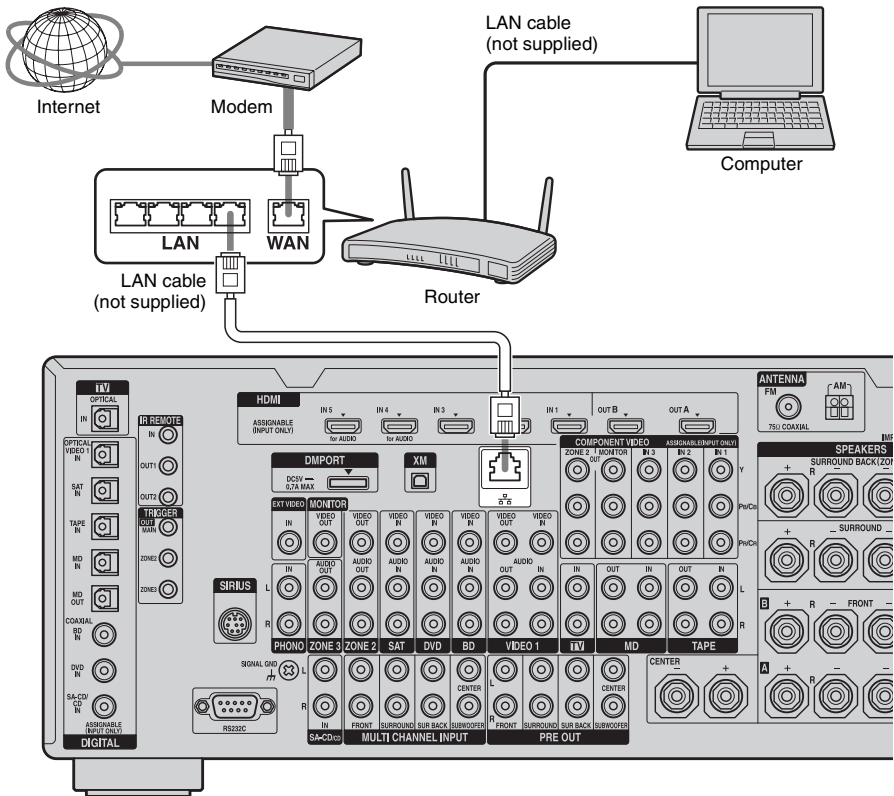

Note

A audio or video playback on the computer may occasionally be interrupted when you use a wireless connection.

6: Preparing the receiver and the remote

Connecting the AC power cord (mains lead)

Connect the supplied AC power cord (mains lead) to the AC IN terminal on the receiver, then connect the AC power cord (mains lead) to a wall outlet.

Notes

- Before connecting the AC power cord (mains lead), make sure that metallic wires of the speaker cords are not touching each other between the SPEAKERS terminals.
- Connect the AC power cord (mains lead) firmly.

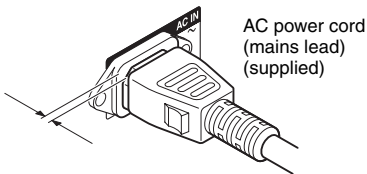
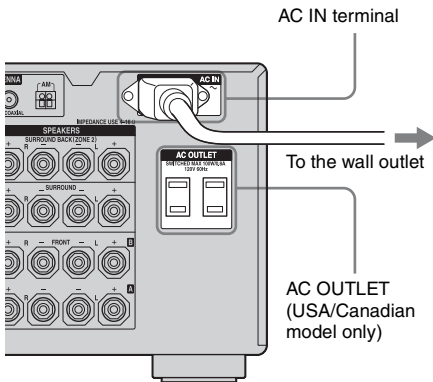

A several space is left between the plug and the rear panel even when the power cord (mains lead) is inserted firmly. The cord is supposed be connected this way. This is not malfunction.

Performing initial setup operations

Before using the receiver for the first time, initialize the receiver by performing the following procedure. This procedure can also be used to return settings you have made to their factory defaults.

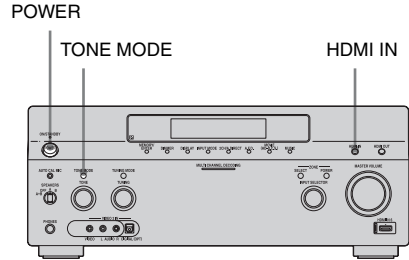

- 1 Press POWER to turn off the receiver.**
- 2 Hold down POWER while pressing TONE MODE and HDMI IN to turn on the receiver.**
- 3 Release the TONE MODE and HDMI IN after a few seconds.**

After “MEMORY CLEARING...” appears on the display for a while, “MEMORY CLEARED.” appears.

All the settings you have changed or adjusted are reset to the initial settings.

Note

It takes about 30 seconds for the memory to be cleared completely. Do not turn the receiver off until “MEMORY CLEARED.” appears on the display.

Inserting batteries into the remote

Insert two R6 (size-AA) batteries in the RM-AAL021 or RM-AAL022 remote commander. Insert two R6 (size-AA) batteries in the RM-AAU061 remote control.

Observe the correct polarity when installing batteries.

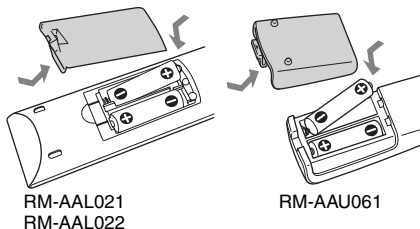

Notes

- Do not leave the remote in an extremely hot or humid place.
- Do not use a new battery with old ones.
- Do not mix manganese batteries and other kinds of batteries.
- Do not expose the remote sensor to direct sunlight or lighting apparatuses. Doing so may cause a malfunction.
- If you do not intend to use the remote for an extended period of time, remove the batteries to avoid possible damage from battery leakage and corrosion.
- When you replace the batteries, the programmed remote codes may be cleared. If this happens, program the remote codes again (page 172).

Tip

When the remote no longer operates the receiver, replace all the batteries with new ones.

7: Setting the speakers

Setting the speaker impedances

Set the appropriate speaker impedance for the speakers you are using.

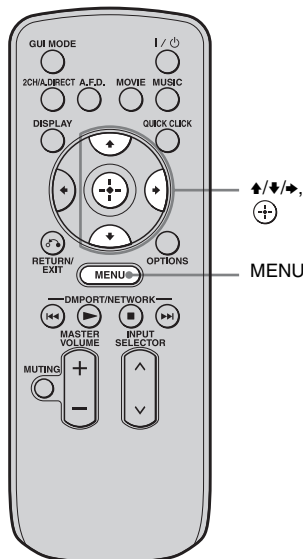

1 Press MENU.

The menu is displayed on the TV screen.

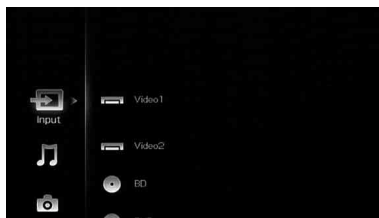

2 Press \uparrow/\downarrow repeatedly to select “Settings,” then press \oplus or \rightarrow .

The Settings menu list appears on the TV screen.

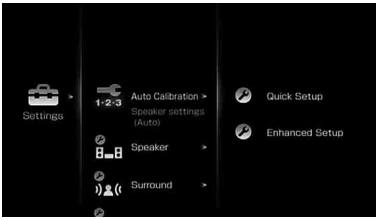

- 3** Press \uparrow/\downarrow repeatedly to select “Speaker,” then press \oplus or \rightarrow .

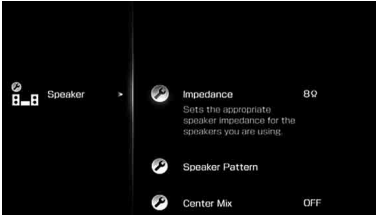

- 4** Press \uparrow/\downarrow repeatedly to select “Impedance,” then press \oplus .

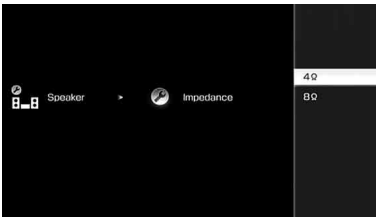

- 5** Press \uparrow/\downarrow repeatedly to select “4 Ω ” or “8 Ω ” depending on the speakers you are using, then press \oplus .

The parameter you have selected is entered.

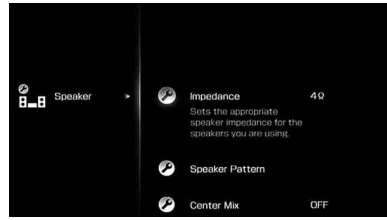

To exit the menu

Press MENU.

Notes

- If you are not sure of the impedances of the speakers, refer to the operating instructions supplied with your speakers. (This information is often on the back of the speaker.)
- When you connect all speakers with a normal impedance of 8 ohms or higher, set “Impedance” to “8 Ω .” When connecting other types of speakers, set it to “4 Ω .”
- When you connect front speakers to both the SPEAKERS A and B terminals, connect the speakers with a normal impedance of 8 ohms or higher.
 - When you connect speakers with impedance of 16 ohms or higher in both “A” and “B” configuration:
Set “Impedance” to “8 Ω ” in the Speaker settings menu.
 - For other types of speakers in other configurations:
Set “Impedance” to “4 Ω ” in the Speaker settings menu.

Selecting the front speakers

You can select the front speakers you want to drive.

SPEAKERS switch

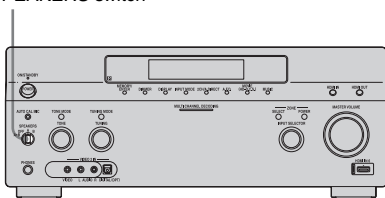

Set the SPEAKERS switch to select the front speaker system you want to drive.

Note

This setting is not available when headphones are connected.

Set to	To select
A	The speakers connected to the FRONT SPEAKERS A terminals.
B	The speakers connected to the FRONT SPEAKERS B terminals.
A+B	The speakers connected to both the FRONT SPEAKERS A and B terminals (parallel connection).
OFF	No audio signals are output from any speaker terminals, or the PRE OUT jacks.

8: Calibrating the appropriate speaker settings automatically (Auto Calibration)

The DCAC (Digital Cinema Auto Calibration) function allows you to perform automatic calibration, such as checking the connection between each speaker and the receiver, adjusting the speaker level, and measuring the distance of each speaker from your seating position automatically.

Before you perform the auto calibration

Before you perform the auto calibration, set up and connect the speakers (page 21-24).

- The AUTO CAL MIC jack is used for the supplied optimizer microphone only. Do not connect other microphones. Doing so may damage the receiver and the microphone.
- During the measurement, the sound that comes out of the speakers is very loud. The volume of the sound cannot be adjusted. Pay attention to the presence of children or to the effect on your neighborhood.
- Perform the measurement in a quiet environment to avoid the effect of noise and get a more accurate measurement.
- If there are any obstacles in the path between the optimizer microphone and the speakers, the calibration cannot be performed correctly. Remove any obstacle from the measurement area to avoid measurement error.
- When you use a bi-amplifier connection, set “Sur Back Assign” to “BI-AMP” in the Speaker settings menu before you perform auto calibration.

Notes

- The auto calibration function does not work if headphones are connected.
- Cancel MUTING if it is set to on.

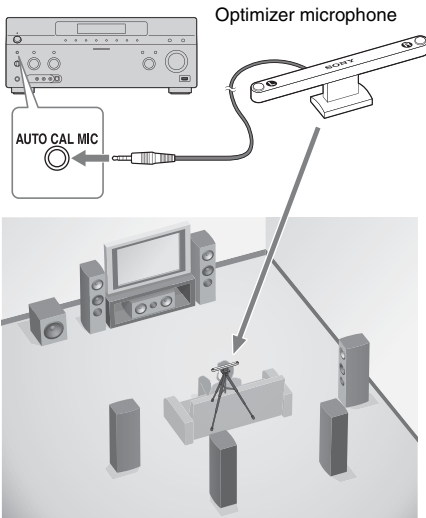

1 Connect the supplied optimizer microphone to the AUTO CAL MIC jack.

2 Set up the optimizer microphone.

Place the optimizer microphone at your seating position. Use a stool or tripod so that the optimizer microphone remains at the same height as your ears. Orient the L end of the optimizer microphone toward the front left speaker and the R end of the optimizer microphone toward the front right speaker.

Note

When you position the optimizer microphone at the center of the two speakers, if the angle between the two speakers is too narrow, the optimizer microphone cannot measure the left and right speakers properly.

On setting up the active subwoofer

- When a subwoofer is connected, turn on the subwoofer and turn up the volume beforehand. Turn the MASTER VOLUME knob to just before the mid-point.

- If you connect a subwoofer with the crossover frequency function, set the value to maximum.
- If you connect a subwoofer with an auto standby function, set it to off (deactivated).

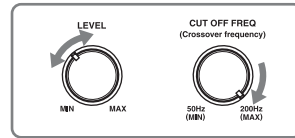

Note

Depending on the characteristics of the subwoofer you are using, the setup distance value may be further away from the actual position.

To use the receiver as a pre-amplifier

You can use the auto calibration function when you use the receiver as a pre-amplifier. In this case, the distance value shown on the display may differ from the actual distance value. However, there will be no problems even if you continue to use the receiver with that value.

Performing auto calibration

The auto calibration function allows you to measure the following:

- Speaker connections^{a)}
 - Polarity of speakers
 - Speaker distance^{b)}
 - Speaker size^{b)}
 - Speaker level
 - Frequency characteristics^{b) c)}
- a) This receiver corrects signals by analog downmix processing only for the center speaker and subwoofer when the multi-channel input is selected. The correction is invalid for other speakers.
- b) The measurement result is not utilized in the following cases.
- The multi-channel input is selected.
 - “2ch Analog Direct” is being used.

- c) • Signals with a sampling frequency of 88.2 kHz and higher are always played back at either 44.1 kHz or 48 kHz.
- The measurement result is not utilized when Dolby TrueHD signals with a sampling frequency of 176.4 kHz and higher are being received.

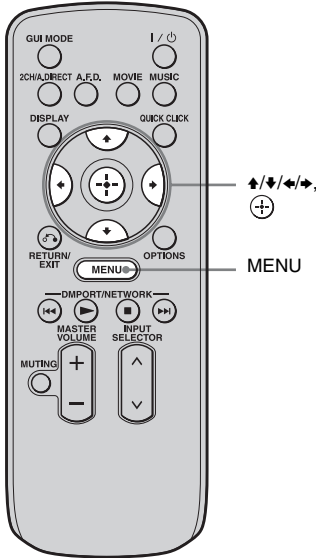

1 Press MENU.

The menu is displayed on the TV screen.

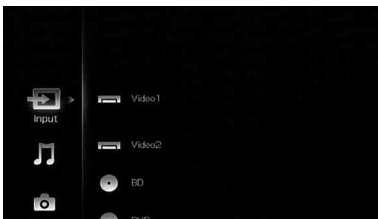

2 Press \uparrow/\downarrow repeatedly to select “Settings,” then press \oplus or \rightarrow .

The Settings menu list appears on the TV screen.

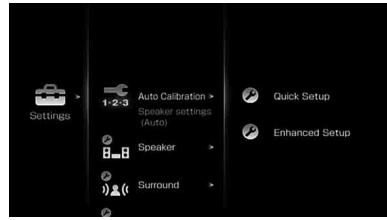

3 Press \uparrow/\downarrow repeatedly to select “Auto Calibration,” then press \oplus or \rightarrow .

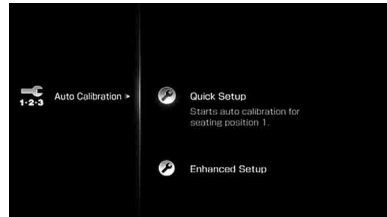

4 Press \uparrow/\downarrow repeatedly to select “Quick Setup,” then press \oplus .

The screen on which you can select the item to be measured appears.

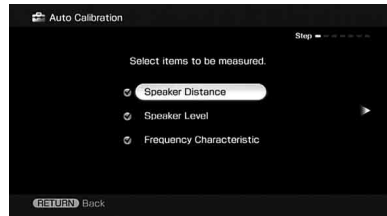

5 Press \uparrow/\downarrow repeatedly and \oplus to un-check the items you do not want to measure, then press \rightarrow .

The confirmation screen, asking whether you are ready to start measurement, appears.

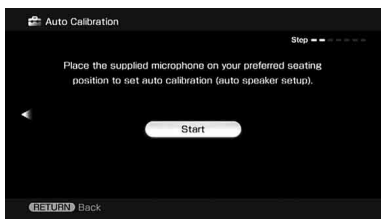

6 Press **+** to select “Start.”

The measurement starts in five seconds. When the measurement ends, a beep sounds and the measurement result appears on the TV screen.

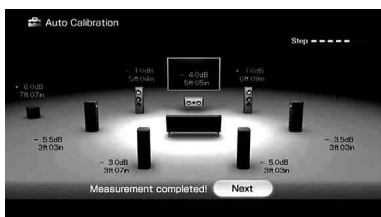

7 Press **+** to select “Next.”

“Save auto calibration (auto speaker setup)?” appears. To save the measurement results, follow the steps in “Saving the measurement results” (page 54).

If a warning message or error code appears on the screen, see “Message list after auto calibration measurement” (page 55).

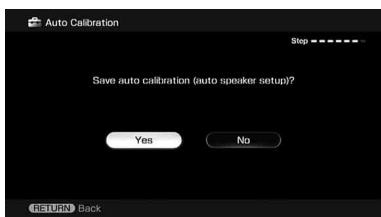

Note

When the speaker(s) is (are) out of the phase, “Out Phase” is displayed on the TV screen. The “+” and “-” terminals of the speaker may be connected the other way around. However, depending on the speakers, “Out Phase” appears on the TV screen even though the speakers are connected properly. This is because of the speakers’ specifications. In this case, you can continue to use the receiver.

Tips

- Operations other than turning the receiver on or off are deactivated during the measurement.
- In the following situations, the measurements have not been performed correctly or auto calibration cannot be performed.
 - when connecting special speakers, such as dipole speakers.
 - when using the zone 2/zone 3 function in zone 2/zone 3.
- You can change the unit of distance use in “Distance Unit” in the Speaker settings menu.

To cancel the measurement

The measurement is cancelled when you change the volume, switch functions, change the setting of the SPEAKERS switch, or connect headphones.

Saving the measurement results

To save the measurement results obtained in “Performing auto calibration” (page 51), proceed with the following steps.

- 1 Press \leftarrow/\rightarrow to select “Yes” in step 7 in “Performing auto calibration” (page 51), then press \oplus .**

The selecting screen of the calibration type appears.

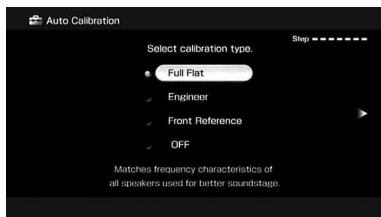

- 2 Press \uparrow/\downarrow repeatedly to select the auto calibration type, then press \oplus .**

Parameter	Explanation
Full Flat	Makes the measurement of frequency from each speaker flat.
Engineer	Sets the frequency to one that matches that of the Sony listening room standard.
Front Reference	Adjusts the characteristics of all the speakers to match the characteristics of the front speaker.
OFF	Sets the auto calibration EQ to off.

The measurement results are saved.

- 3 Press \rightarrow .**

The exit screen appears.



- 4 Press \oplus .**

Notes

- After reflecting the results of a compensation for a frequency characteristic, signals with a sampling frequency of 88.2 kHz and higher are always played back at either 44.1 kHz or 48 kHz.
- The frequency response measurement result is not utilized in the following cases.
 - The multi-channel input is selected.
 - “2ch Analog Direct” is being used.
 - Dolby TrueHD signals with a sampling frequency of 176.4 kHz and higher are being received.

Tip

The size of a speaker (LARGE/SMALL) is determined by the low characteristics. The measurement results may vary, depending on the position of the optimizer microphone and speakers, and the shape of the room. It is recommended that you follow the measurement results. However, you can change those settings in the Speaker settings menu. Save the measurement results first, then try to change the settings if you want.

Checking the auto calibration results

If a warning message or error code appears in step 7 of “Performing auto calibration” (page 51), check the problem of the error and perform auto calibration again.

- 1 Press **←/→** to select “Yes,” then press **⊕** when “Error occurred during calibration, press to investigate.” appears on the screen.

Confirm the details of the measurement results, then proceed with the appropriate remedy.

- 2 Press **←/→** to select “Retry,” then press **⊕**.

- 3 Repeat steps 5 to 7 in “Performing auto calibration” (page 51).

To save measurement results that caused an error without taking a remedy

- 1 Press **←/→** to select “No”, then press **⊕** when “Error occurred during calibration, press to investigate.” appears on the screen.
- 2 Follow the steps in “Saving the measurement results” (page 54) to save the measurement results.

Message list after auto calibration measurement

Display	Explanation
Code 30	Headphones are connected. Remove the headphones and perform the auto calibration again.
Code 31	SPEAKERS (OFF/A/B/A+B) is set to OFF. Set it to others and re-perform the measurement.
Code 32	None of the speakers were detected. Make sure that the optimizer microphone is connected properly and reperform the measurement. If the optimizer microphone is connected properly but the error code appears, the optimizer microphone cable may be damaged or improperly connected.
Code 33	<ul style="list-style-type: none"> • None of the front speakers are connected or only one front speaker is connected. • The optimizer microphone is not connected. • Either the left or right surround speaker is not connected. • Surround back speakers are connected even though surround speakers are not connected. Connect the surround speaker(s) to the SURROUND terminals. • The surround back speaker is connected only to the SURROUND BACK SPEAKERS R terminals. When you connect only one surround back speaker, connect it to the SURROUND BACK SPEAKERS L terminals.
Code 34	Speakers are not placed in the proper position. Speakers or an optimizer microphone on the right or left may be placed wrongly. See “1: Installing speakers” (page 21) and check the speaker position.
Warning 40	The measurement has completed. However, the noise level is high. You may be able to perform the measurement properly if you try it again, even though the measurement cannot be performed in all environments. Try to perform the measurement in a quiet environment.
Warning 41	The input from the microphone is too big.
Warning 42	<ul style="list-style-type: none"> • It may be too close the distance between the speaker and the microphone. Retry the measurement after setting apart from each other. <ul style="list-style-type: none"> • It may be that the volume is too big when you use the receiver as a preamp.
Warning 43	The distance and position of a subwoofer cannot be detected. Or the angle of the speaker position cannot be detected. This may be caused by noise. Try to perform the measurement in a quiet environment.

continued

Display	Explanation
Warning 44	Measurement has been completed. However the speakers are not placed in the proper position with respect to each other. See “1: Installing speakers” (page 21) and check the relative positions of the speakers.
NO WARNING	There is no warning information.
-----	No speakers are connected.

Tip

Depending on the position of the subwoofer, the measurement results for polarity may vary.

However, there will be no problems even if you continue to use the receiver with that value.

9: Configuring the network settings of the receiver

The network settings for the receiver must be set correctly to use the network functions of the receiver.

You can make the required network settings for the receiver by following the instructions provided by an initial setup wizard.

The procedure used to set up the IP address automatically (DHCP) is explained below. In this case, the router that is connected to the receiver or the Internet provider must support DHCP.

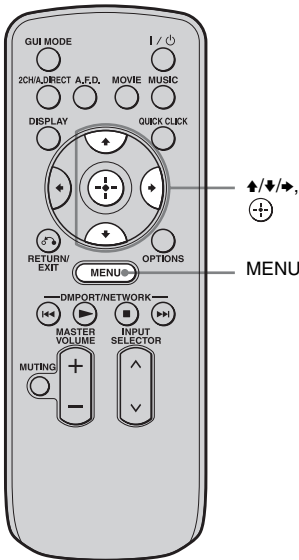

1 Press MENU.

The menu is displayed on the TV screen.

2 Press ↑/↓ repeatedly to select “Settings,” then press ⊕ or ↘.

3 Press ↑/↓ repeatedly to select “Network,” then press ⊕ or ↘.

4 Press ↑/↓ repeatedly to select “Network Setup,” then press ⊕.

“Start Network function Setup Wizard” appears on the TV screen.

5 Press ⊕ to select “Next.”

6 Press ⊕ to select “Connect Automatically (DHCP).”

“Success! The receiver is now connected to network.” appears on the TV screen when you have succeeded in making a connection.

If the failure screen is displayed, perform the process referring to “Network Setup” (page 144), after you have completed this process.

7 Press ⊕ to select “Finish.”

To set the network settings manually

See “To set the IP address manually” (page 144) or “To set the Proxy server manually” (page 144).

Note

The wizard screen appears on the TV screen each time you use the network function, until the network function setup has been completed.

10: Preparing a computer to use as a server

A server is a device which delivers content (music, photos, and videos) to a DLNA device on a home network.

You can play back content stored on a computer on a home network with this receiver via that network after you have installed application software such as VAIO Media plus which has a DLNA compliant sever function.

What you can do with VAIO Media plus

VAIO Media plus is an application software that enables you to quickly find content on your home network, such as music, photos, and videos, and view the content on the computer through the home network.

By connecting other devices to VAIO Media plus, you can also find and view the content on the connected devices through the home network. For example, you can enjoy photos and music, stored on your computer, on your TV and audio device or play a TV program, recorded with a hard disk recorder, on your computer.

If you use a VAIO computer, you can deliver content saved on an external hard disk drive or in Network-Attached Storage (NAS).

Note

If you use a computer other than a VAIO, you can only deliver content saved on the internal disk drive of that computer.

System Requirements

Operating System

Windows XP Home Edition/Professional/ Media Center Edition 2004/Media Center Edition 2005 (SP3, 32 bit)

Windows Vista Home Basic/Home Premium/ Business/Ultimate (SP1, 32 bit/64 bit)

Computer

	Windows XP	Windows Vista
Computer	IBM PC/AT compatible	
CPU	Intel Celeron M processor 1.40 GHz or higher (Intel Core 2 Duo 1.80 GHz or higher is recommended.)	Intel Core Duo 1.33 GHz or higher (Intel Core 2 Duo 2.26 GHz or higher is recommended.)
Memory	512 MB or more (1 GB or more is recommended.)	1 GB or more (2 GB or more is recommended.)
Graphic chip	Equipped with graphic chip by Intel, NVIDIA or ATI. DirectX 9.0c compatible video card (DirectX 9.0c/128 MB compatible video card and the latest driver are recommended.)	
Display	800 × 600 or higher resolution	
HDD	500 MB or more is recommended.	
Network	100Base-TX or higher	
Sound card	Direct Sound compatible sound card	

Note

Sony does not guarantee trouble-free operation on all computers that satisfy the system requirements. Other software operating on background may affect the operation of this software.

Installing the VAIO Media plus application software on a computer

When you use VAIO Media plus as server software, install on your computer the VAIO Media plus application software provided on the CD-ROM supplied with the receiver by following steps below.

If an older version of VAIO Media plus has already been installed on your computer, uninstall the following three programs using “Programs and Features” (for Windows Vista) or “Add or Remove Programs” (for Windows XP) in Control Panel beforehand.

- VAIO Media plus
- VAIO Content Folder Watcher
- VAIO Content Folder Setting

- 1 Turn on your computer and login as an administrator.
- 2 Insert the supplied CD-ROM into the CD-ROM drive of your computer.

The installation launcher starts automatically, then a Software Setup window appears on the screen. If installation launcher does not start automatically, double-click “SetupLauncher.exe” on the disc.

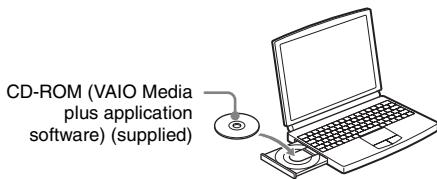

- 3 Install the VAIO Media plus application software following the instructions given in the message on the screen.

Referring to help files

For VAIO Media plus operations, refer to the help files. Click “ Settings” in the Home Menu window, then select “ Help” to display help files.

Guide to on-screen display operation

You can display the menu of the receiver on the TV screen and select the function you want to use on the TV screen by pressing /// and on the remote.

To display the menu of the receiver on the TV screen, make sure that the receiver is in “GUI MODE” following the step in “To turn “GUI MODE” on and off” (page 60).

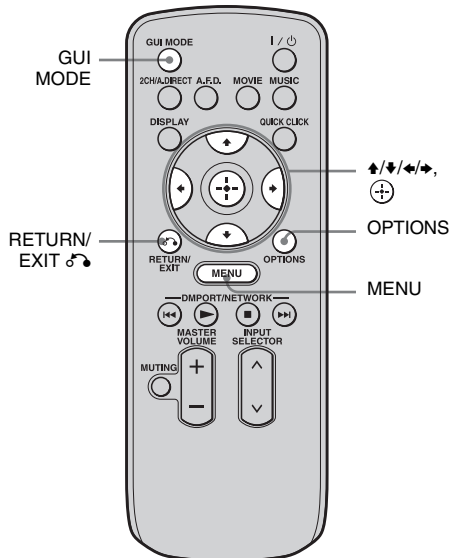

Using the menu

1 Press MENU.

The menu is displayed on the TV screen.



2 Press \uparrow/\downarrow repeatedly to select the menu you want, then press \ominus or \rightarrow to enter the menu mode.

The menu item list appears on the TV screen.

Example: When you select “ Input”

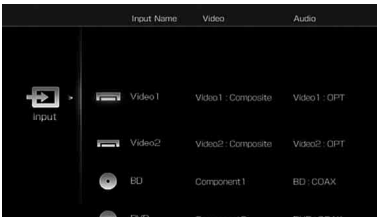

3 Press \uparrow/\downarrow repeatedly to select the menu item you want to adjust, then press \oplus to enter the menu item.

4 Repeat steps 2 and 3 to select the parameter you want.

To return to the previous screen

Press RETURN/EXIT .









To exit the menu

Press MENU.

To turn “GUI MODE” on and off

Press GUI MODE. “GUI MODE ON” or “GUI MODE OFF” is displayed in the display window of the receiver, depending on the mode selected.

Overview of the main menus

Menu icon	Description
	Input Selects the input source component connected to the receiver (page 62).
	Music Selects the music from the audio component connected to the DIGITAL MEDIA PORT adapter (page 64) or server on the home network.
	Photo Select the photos from the server on the home network.
	Video Select the images from the video component connected to the DIGITAL MEDIA PORT adapter (page 64) or server on the home network.
	Rhapsody Selects the Rhapsody radio service (page 98). Rhapsody is only available in the US.
	SHOUTcast Selects the SHOUTcast radio service (page 101).
	FM/AM/XM/SIRIUS Selects the built-in FM/AM radio or satellite tuner connected (page 68, 73).
	Settings You can adjust the settings of the speakers, the surround effect, equalizer, audio, video and other inputs connected to the HDMI jacks (page 127).

Using the option menus

When you press **OPTIONS**, the option menus for the selected main menu are displayed. You can select a related function without reselecting the menu.

1 Press **MENU**.

The menu is displayed on the TV screen.

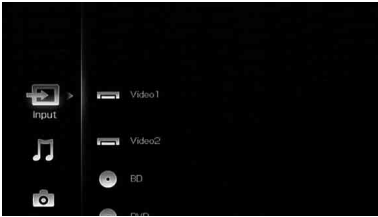

2 Press **↑/↓** repeatedly to select a menu you want, then press **⊕** or **→** to enter the menu mode.

The menu item list appears on the TV screen.

Example: When you select “**Input**”



3 Press **OPTIONS** while the menu item list is displayed.

The option menu appears.

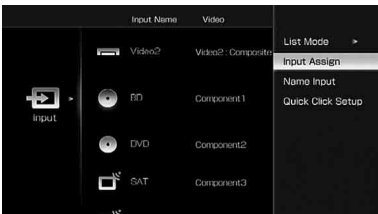

4 Press **↑/↓** repeatedly to select the option menu item you want, then press **⊕**.

5 Press **↑/↓** repeatedly to select the parameter you want, then press **⊕**.

To exit the menu

Press **MENU**.

Playback

Enjoying sound/images from the component connected to the receiver

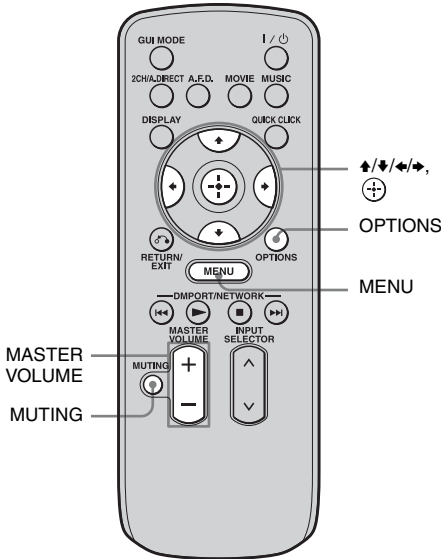

1 Press MENU.

The menu is displayed on the TV screen.

2 Press **↑/↓** repeatedly to select “Input,” then press **⊕** or **→**.

The menu item list appears on the TV screen.

3 Press **↑/↓** repeatedly to select the component you want, then press **⊕**.

The menu screen disappears and the playback screen of the external input appears.

Selected input	Components that can be used
Video 1, Video 2	VIDEO 1, 2 VCR, etc., connected to the VIDEO 1 or VIDEO 2 jack.
BD	Blu-ray Disc Player, etc., connected to the BD jack.
DVD	DVD player, etc., connected to the DVD jack.
SAT	Satellite tuner, etc., connected to the SAT jack.
TV	TV connected to the TV jack.
Tape	Tape deck, etc., connected to the TAPE jack.
MD	MD deck, etc., connected to the MD jack.
SA-CD/CD	Super Audio CD or CD player, etc., connected to the SA-CD/CD jack.
Phono	Turntable, etc., connected to the PHONO jack.
Multi in	Component connected to the MULTI CHANNEL INPUT jack.
HDMI 1, 2, 3, 4, 5, 6	HDMI components connected to the HDMI1, HDMI2, HDMI3, HDMI4, HDMI5, or HDMI6 jack.

4 Turn on the component and start playback.

5 Press MASTER VOLUME +/- to adjust the volume.

Tips

- You can adjust the volume differently depending on the speed with which you turn the MASTER VOLUME knob.

To turn the volume up or down quickly: turn the knob quickly.

To make fine adjustment: turn the knob slowly.

- You can adjust the volume differently depending on the length of time you press and hold the MASTER VOLUME +/- button on the remote.

To turn the volume up or down quickly: press and hold the button.

To make a fine adjustment: press the button and release it immediately.

To activate the muting function

Press MUTING on the remote. To cancel, press MUTING on the remote again or press MASTER VOLUME + to raise the volume.

To avoid damaging your speakers

Before you turn off the receiver, be sure to turn down the volume level.

Naming the input (Name Input)

You can enter a name of up to 8 characters for inputs and display it.

This is convenient for labeling the jacks with the names of the connected components.

- 1 Press \uparrow/\downarrow repeatedly on the “Input” screen to select the input you want to name.**

- 2 Press OPTIONS.**

The option menu appears.

- 3 Press \uparrow/\downarrow repeatedly to select “Name Input,” then press \oplus .**

The soft keyboard appears on the screen.

- 4 Press $\uparrow/\downarrow/\leftarrow/\rightarrow$ and \oplus to select a character one by one to enter the name.**

- 5 Press $\uparrow/\downarrow/\leftarrow/\rightarrow$ to select “Finish,” then press \oplus .**

The name you entered is registered.

To cancel naming input

Press $\uparrow/\downarrow/\leftarrow/\rightarrow$ to select “Cancel,” then press \oplus .

Changing the display items (List Mode)

When you select “Input,” you can change the items to be displayed.

- 1 Press \uparrow/\downarrow repeatedly on the “Input” screen to select the input you want.**

- 2 Press OPTIONS.**

The option menu appears.

- 3 Press \uparrow/\downarrow repeatedly to select “List Mode,” then press \oplus .**

- 4 Press \uparrow/\downarrow repeatedly to select the item you want to display, then press \oplus .**

- Input Assign

Input name and audio/video input jack assigned to the input are displayed in a list.

- Sound Field

Input name and the sound field selected for the input are displayed in a list.

- A/V Sync

Input name and the delay set on the “A/V Sync” menu for the input are displayed in a list.

Enjoying sound/images from the components connected to the DIGITAL MEDIA PORT

The DIGITAL MEDIA PORT is for enjoying sound/images from a portable audio source or computer by connecting a DIGITAL MEDIA PORT adapter.

Available DIGITAL MEDIA PORT adapters vary in each area.

For details on connecting the DIGITAL MEDIA PORT adapter, see “Connecting components with digital audio input/output jacks” (page 28).

You can use the following Sony DIGITAL MEDIA PORT adapters:

- TDM-BT1/BT10 Bluetooth™ Wireless Audio Adapter
- TDM-NW10 DIGITAL MEDIA PORT Adapter
- TDM-iP10/iP50 DIGITAL MEDIA PORT Adapter
- TDM-MP10 DIGITAL MEDIA PORT Adapter

The DIGITAL MEDIA PORT adapter is an optional product.

Notes

- Do not connect an adapter other than the DIGITAL MEDIA PORT adapter.
- Before disconnecting the DIGITAL MEDIA PORT adapter, make sure to turn the receiver off using the remote.
- Do not connect or disconnect the DIGITAL MEDIA PORT adapter to/from the receiver while the system is turned on.
- Depending on the type of DIGITAL MEDIA PORT adapter, the images are also output.
- Do not connect to the receiver a DIGITAL MEDIA PORT adapter that uses a network function such as TDM-NC1 Wireless Network Audio Client.

You can use the network function of the receiver without using a DIGITAL MEDIA PORT adapter.

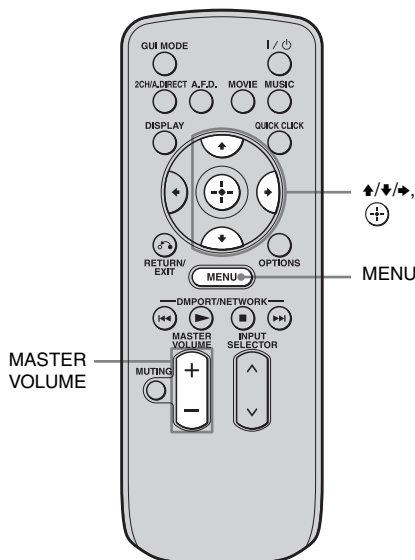





1 Press MENU.

The menu is displayed on the TV screen.

2 Press ↑/↓ repeatedly to select “♪ Music” or “📺 Video,” then press ⊕ or →.

3 Press ↑/↓ repeatedly to select “DMPort” or a component connected to the DIGITAL MEDIA PORT adapter, then press ⊕.

The component connected to the DIGITAL MEDIA PORT adapter is recognized and “DMPort” on the screen will change to the respective component’s name with an icon. If the adapter connected cannot be recognized, “DMPort” is displayed on the TV screen.



Icon	Component that is connected
	DMPORT A component other than one of the following is connected.
	iPod The iPod model recognized is connected.
	Walkman The Network Walkman recognized is connected.
	Bluetooth The Bluetooth drive recognized is connected.
	Mobile Phone The Mobile Phone recognized is connected.

- 4** Select a track you want to play using the component connected to the DIGITAL MEDIA PORT adapter.
- 5** Press MASTER VOLUME +/- to adjust the volume.

Operating the TDM-iP50 using the GUI menu of the receiver

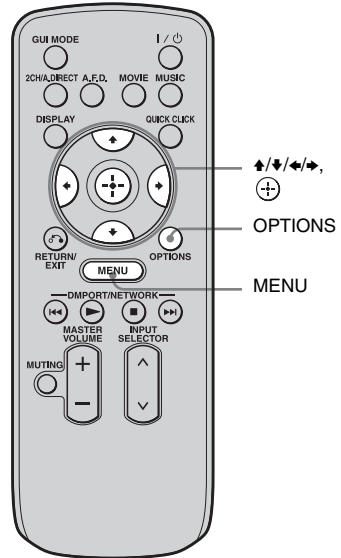
Make sure that “System GUI” is selected in step 4 in “Changing the operation screen using the DIGITAL MEDIA PORT” (page 67).



- 1** Press MENU.
The menu is displayed on the TV screen.
- 2** Press \uparrow/\downarrow repeatedly to select “ Music” or “ Video,” then press \oplus or \rightarrow .
- 3** Press \uparrow/\downarrow repeatedly to select the component connected to the DIGITAL MEDIA PORT adapter you want to play, then press \oplus .
The contents list appears.

4 Press $\blacktriangle/\blacktriangledown/\blacktriangleleft/\blacktriangleright$ and \oplus to select track or content from the contents list.

The following content lists are just examples. They may vary depending on the components connected to the receiver.

In case of iPod

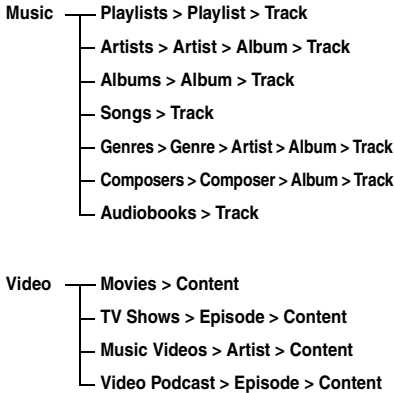

5 Press MASTER VOLUME +/- to adjust the volume.

Selecting the playback mode

1 Play back the track you want to listen to following the steps outlined in “Operating the TDM-iP50 using the GUI menu of the receiver” (page 65).

2 Press **OPTIONS**.

The option menu appears.

3 Press $\blacktriangle/\blacktriangledown$ repeatedly to select “Shuffle,” “Repeat,” or “Audiobook Speed,” then press \oplus .

4 Press $\blacktriangle/\blacktriangledown$ repeatedly to select the mode you want to select from the following, then press \oplus .

■ Shuffle

Plays all the tracks in random order.

- Off
Deactivates the shuffle play mode.
- Albums
Plays all the tracks on an album in random order.
- Songs
Plays all the tracks in “Songs” in random order.

■ Repeat

Plays one or all the tracks repeatedly.

- Off
Deactivates the repeat play mode.
- One
Plays one track repeatedly.
- All
Plays all the tracks repeatedly.

■ Audiobook Speed

Selects the display speed of the Audiobook.



- Low
Slows the display speed.
- Normal
Sets the display speed to standard.
- High
Increases the display speed.

DIGITAL MEDIA PORT message list

Message appears	Explanation
No Adapter	The adapter is not connected.
No Device	There is no device connected to the adapter.
No Audio	No audio file was found.
Loading	The data is being read.
No Item	No item was found.

Changing the operation screen using the DIGITAL MEDIA PORT

You can change the operation screen using the GUI menu. The DMPORT Control mode is supported by the DIGITAL MEDIA PORT adapters like TDM-iP50. This mode is not supported by other adapters.

1 Press \uparrow/\downarrow repeatedly on the “ Music” or “ Video” screen to select the DIGITAL MEDIA PORT adapter you want, then press  or \rightarrow .

2 Press OPTIONS.

The option menu appears.

3 Press \uparrow/\downarrow to select “DMPORT Control,” then press .

If “DMPORT Control” is not displayed, refer to the operating instructions supplied with component for details on operating that component.

4 Press \uparrow/\downarrow repeatedly to select the mode you want, then press .

You can select the following modes in this menu;

- System GUI

This mode is for the TDM-iP50. The list of tracks will be displayed on the GUI screen of the receiver. You can select a track you want and play back it on each GUI screen.

- Adapter GUI

This mode is for the TDM-iP50. The menu of the adapter will be displayed on the TV screen.

- iPod

This mode can be selected only when the TDM-iP50 is connected.

To operate the TDM-iP50 using the adapter menu

Make sure that “Adapter GUI” is selected in step 4 in “Changing the operation screen using the DIGITAL MEDIA PORT” (page 67).

For details on operating the adapter using the adapter GUI menu, refer to the operating instructions supplied with the adapter you are using.

To operate the TDM-iP50 using the iPod menu

Make sure that “iPod” is selected in step 4 in “Changing the operation screen using the DIGITAL MEDIA PORT” (page 67).

For details on operating the iPod, refer to the operating instruction supplied with the iPod.

Tuning

Listening to FM/AM radio

You can listen to FM and AM broadcasts through the built-in tuner. Before operation, make sure you have connected the FM and AM antennas (aerials) to the receiver (page 44).

Tip

The tuning scale for direct tuning is shown below.

- FM band 100 kHz (USA/Canadian model)
50 kHz (European model)
- AM band 10 kHz* (USA/Canadian model)
9 kHz (European model)

* The AM tuning scale can be changed (page 71).

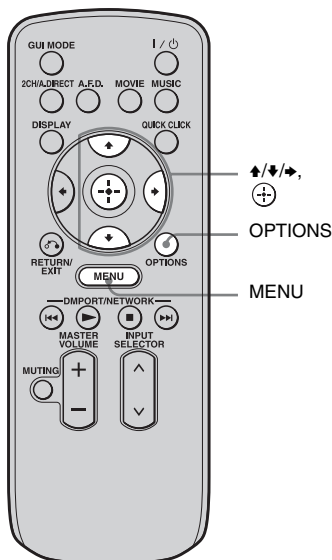

Tuning into a station automatically (Auto Tuning)

- 1 Press MENU.**
The menu is displayed on the TV screen.
- 2 Press ↑/↓ repeatedly to select “FM FM” or “AM AM,” then press ⊕ or →.**
The FM or AM menu list appears on the TV screen.
- 3 Press ↑/↓ to select “Auto Tuning,” then press ⊕.**
- 4 Press ↑/↓.**
Press ↑ to scan from low to high, press ↓ to scan from high to low.
The receiver stops scanning whenever a station is received.

In case of poor FM stereo reception

- 1 Tune in the station you want to listen to using Auto Tuning, Direct Tuning (page 69), or select the preset station you want (page 72).**
- 2 Press OPTIONS.**
The option menu appears.
- 3 Press ↑/↓ to select “FM Mode,” then press ⊕.**
- 4 Press ↑/↓ to select “MONO,” then press ⊕.**

Tuning into a station directly (Direct Tuning)

Enter the frequency of a station directly by using the numeric buttons on the multifunction remote. This operation cannot be performed using the simple remote.

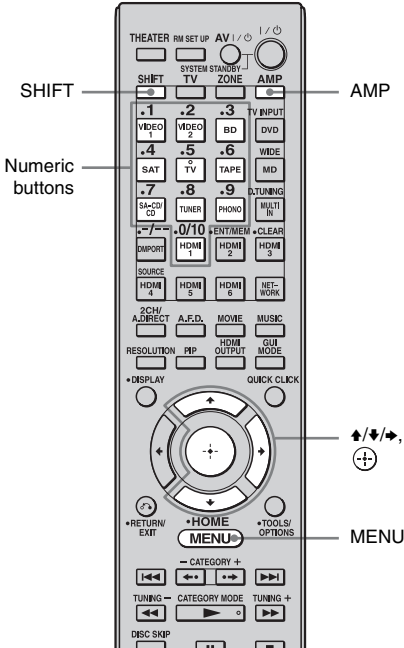

5 Press SHIFT, then press the numeric buttons to enter the frequency, then press \oplus .

Example 1: FM 102.50 MHz
Select 1 \rightarrow 0 \rightarrow 2 \rightarrow 5 (\rightarrow 0*)

Example 2: AM 1,350 kHz
Select 1 \rightarrow 3 \rightarrow 5 \rightarrow 0

*Press the numeric button 0 when you are using the European model.

Tip

If you have tuned in an AM station, adjust the direction of the AM loop antenna (aerial) for optimum reception.

If you cannot tune in a station

“---.--- MHz” appears and then the display returns to the current frequency.

Make sure you have entered the right frequency. If not, repeat step 5. If you still cannot tune in a station, the frequency is not used in your area.

1 Press AMP.

The receiver can be operated using the remote.

2 Press MENU.

The menu is displayed on the TV screen.

3 Press \uparrow/\downarrow repeatedly to select “FM FM” or “AM AM,” then press \oplus or \rightarrow .

4 Press \uparrow/\downarrow to select “Direct Tuning,” then press \oplus .

Receiving RDS broadcasts (European model only)

This receiver also allows you to use RDS (Radio Data System), which enables radio stations to send additional information along with the regular program signal. You can display RDS information.

Select a station on the FM band you want to listen to using Auto Tuning (page 68) or Direct Tuning.

When you tune in a station that provides RDS services, the Program Service Name and Program Type are displayed on the TV screen.

Program type indication	Description
News	News programs
Current Affairs	Topical programs that expand on current news
Information	Programs offering information on a wide spectrum of subjects, including consumer affairs and medical advice
Sport	Sports programs
Education	Educational programs, such as “how-to” and advice programs
Drama	Radio plays and serials
Cultures	Programs about national or regional culture, such as language and social concerns
Science	Programs about the natural sciences and technology
Varied Speech	Other types of programs such as celebrity interviews, panel games, and comedy
Pop Music	Popular music programs
Rock Music	Rock music programs
Easy Listening	Easy Listening
Light Classics M	Instrumental, vocal, and choral music
Serious Classics	Performances of major orchestras, chamber music, opera, etc.

Program type indication	Description
Other Music	Music that does not fit into any categories above, such as Rhythm & Blues and Reggae
Weather & Metr	Weather information
Finance	Stock market reports and trading, etc.
Children’s Progs	Programs for children
Social Affairs	Programs about people and the things that affect them
Religion	Programs of religious content
Phone In	Programs where members of the public express their views by phone or in a public forum
Travel & Touring	Programs about travel. Not for announcements that are located by TP/TA.
Leisure & Hobby	Programs on recreational activities such as gardening, fishing, cooking, etc.
Jazz Music	Jazz programs
Country Music	Country music programs
National Music	Programs featuring the popular music of the country or region
Oldies Music	Programs featuring oldies music
Folk Music	Folk music programs
Documentary	Investigative features
None	Any programs not defined above

Notes

- RDS is operable only for FM stations.
- Not all FM stations provide RDS service, nor do they provide the same type of services. If you are not familiar with the RDS services in your area, check with your local radio stations for details.
- RDS may not work properly if the station you tuned to is not transmitting the RDS signal properly or if the signal strength is weak.
- If there is an emergency announcement by government authorities, “Alarm-Alarm!” flashes in the display.
- If a station does not provide a particular RDS service, “No XX” (such as “No Clock Time”) appears on the display.

- When a station broadcasts radio text data, it is displayed at the same rate at which it is sent from the station. Any change in this rate is reflected in the display rate of the data.
- The RDS information is shown on the display of this receiver.

Changing the AM tuning scale (USA/Canadian model only)

You can change the AM tuning scale to either 9 kHz or 10 kHz on the receiver.

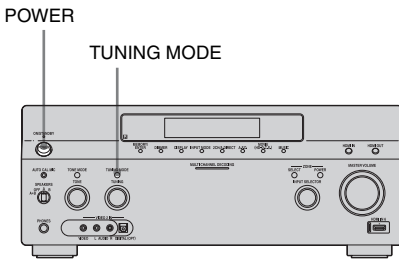

- 1 Press POWER** to turn off the receiver.
- 2 While holding down TUNING MODE**, press **POWER** on the receiver.
- 3 Change the current AM tuning scale to 9 kHz (or 10 kHz).**
To reset the scale to 10 kHz (or 9 kHz), repeat the procedure above.

Note

All preset stations will be erased when you change the tuning scale.

Presetting FM/AM radio stations

You can preset up to 30 FM and 30 AM stations. Then you can easily tune in the stations you often listen to.

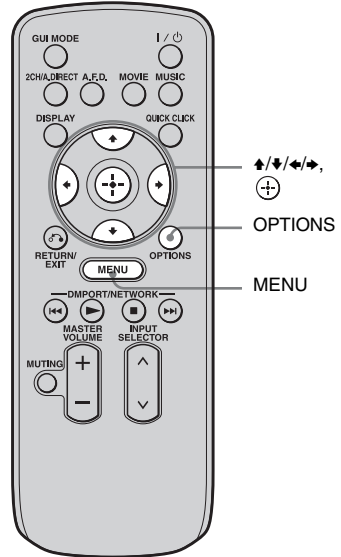

- 1 Tune in the station that you want to preset using Auto Tuning (page 68) or Direct Tuning (page 69).**

In case of poor FM stereo reception, switch the FM reception mode (page 68).

- 2 Press OPTIONS.**

The option menu appears.

- 3 Press ↑/↓ to select “Memory,” then press +.**

- 4 Press ↑/↓ to select a preset number, then press +.**

The station is stored as the selected preset number.

continued

5 Repeat steps 1 to 4 to preset another station.

You can store stations as follows:

- AM band: AM1 to AM30
- FM band: FM1 to FM30

To cancel naming input

Press $\uparrow/\downarrow/\leftarrow/\rightarrow$ to select “Cancel,” then press \oplus .

Tuning to preset stations

1 Press MENU.

The menu is displayed on the TV screen.

2 Press \uparrow/\downarrow repeatedly to select “ FM FM” or “ AM AM,” then press \oplus or \rightarrow .

3 Press \uparrow/\downarrow to select the preset number station you want.

Preset numbers from 1 to 30 are available.

Naming preset stations (Name Input)

1 On “ FM FM” or “ AM AM” screen, press \uparrow/\downarrow to select the preset number on which you want to name.

2 Press OPTIONS.

The option menu appears.

3 Press \uparrow/\downarrow repeatedly to select “Name Input,” then press \oplus .

The soft keyboard appears on the screen.

4 Press $\uparrow/\downarrow/\leftarrow/\rightarrow$ and \oplus to select a character one by one to enter the name.

5 Press $\uparrow/\downarrow/\leftarrow/\rightarrow$ to select “Finish,” then press \oplus .

The name you entered is registered.

Listening to satellite radio (USA/Canadian model only)

To listen to Satellite Radio, you'll need to connect either a SIRIUS or XM Satellite Radio tuner (sold separately) to your satellite-ready receiver. Satellite Radio is available to residents of the US (except Alaska and Hawaii) and Canada.

Satellite Radio delivers a variety of commercial-free music from categories ranging from Pop, Rock, Country, R&B, Dance, Jazz, Classical and many more plus coverage of all the top professional and college sports including play by play games from select leagues and teams. Additional programming includes expert sports talk, uncensored entertainment, comedy, family programming, local traffic and weather and news from your most trusted sources.

Whether you purchase a SIRIUS or XM tuner, you'll need to activate and subscribe to begin enjoying the service. Easy to follow installation and setup instructions are provided with the satellite tuners. Whichever service you choose, there are a variety of programming packages available, including the option of adding "The Best of SIRIUS" programming to your XM tuner or "The Best of XM" programming to your SIRIUS tuner, enabling you to enjoy the most popular programming among both services. The "Best of" packages are not available to SIRIUS or XM Canada subscribers at this time.

Family friendly packages are also available to restrict channels featuring content that may be inappropriate for children.

To subscribe to XM, U.S. customers should visit xmradiocom or call 1-800-XMRADIO (1-800-967-2346); Canadian customers

should visit xmradioca or call XM Listener Care at 1-877-GETXMSR (1-877-438-9677).

To subscribe to SIRIUS, U.S. and Canadian customers can call 1-888-539-SIRI (1-888-539-7474) or visit sirius.com (US) or siriuscanada.ca (Canada).

SIRIUS, XM and all related marks and logos are trademarks of Sirius XM Radio Inc. and its subsidiaries. All other marks and logos are the property of their respective owners. All rights reserved. SIRIUS and XM subscriptions sold separately. Taxes and a one-time activation fee may apply. XM tuners and home docks or SIRIUS tuners (each sold separately) are required to receive the SIRIUS or XM satellite radio service. All programming and fees subject to change. It is prohibited to copy, decompile, disassemble, reverse engineer, hack, manipulate or otherwise make available any technology or software incorporated in receivers compatible with the SIRIUS or XM Satellite Radio Systems. **Service not available in Alaska and Hawaii.**

Connecting a satellite radio tuner

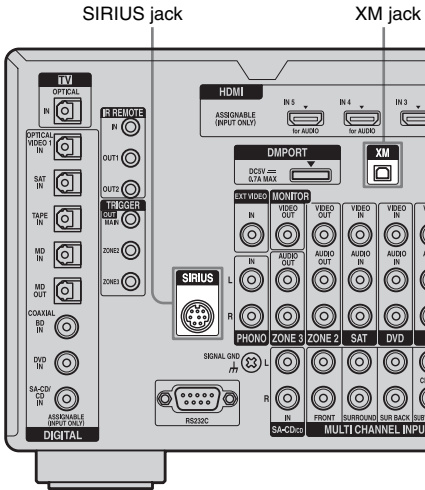

To connect to the XM jack

Before operating the system, connect the XM Mini-Tuner and Home Dock to the XM jack.

Note

To ensure optimal reception of XM's satellite signal, move your antenna to various window locations around your home to see where the best reception will be received. Most XM customers place the antenna in a south-facing window with a clear view to the sky.

To connect to the SIRIUS jack

Connect the SiriusConnect Home tuner. When you use the SiriusConnect Home tuner with this receiver, be sure to connect the AC power adaptor supplied with the tuner to a wall outlet. Keep the SiriusConnect Home tuner, antenna, and AC power adaptor away from the speaker cords and the power cord to avoid picking up noise.

Preparing to listen to a satellite radio

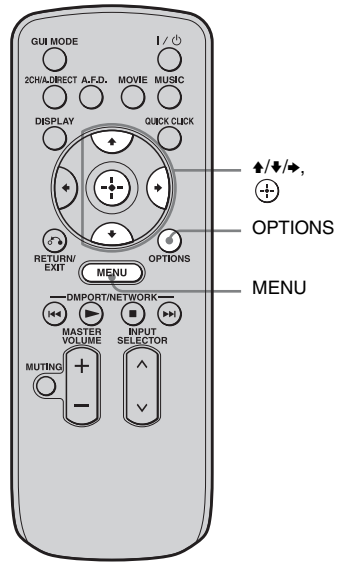

Checking the ID number

- 1 **Press MENU.**
The menu is displayed on the TV screen.
- 2 **Press \uparrow/\downarrow repeatedly to select “ XM XM” or “ SR SIRIUS,” then press \oplus or \rightarrow .**
- 3 **Press \uparrow/\downarrow to select “ALL,” then press \oplus or \rightarrow .**
When the “Preset Mode” screen is displayed, change the tuning mode to “Category Mode,” then select “ALL.” Press OPTIONS, then press \uparrow/\downarrow repeatedly to select “Category Mode.”
- 4 **Press \uparrow/\downarrow to select the channel 0, then press \oplus .**

- 5 Check the XM Radio ID or Sirius ID on the TV screen and write it in the space provided here.

XM Radio ID: _____

Sirius ID: _____

You can also check the XM Radio ID and Sirius ID using the display on the receiver.

Checking receiving conditions (Antenna Aiming)

- 1 Press **MENU**.
The menu is displayed on the TV screen.
- 2 Press **▲/▼** repeatedly to select “**XM XM**” or “**SR SIRIUS**,” then press **⊕** or **➡**.
- 3 Press **OPTIONS**.
The option menu appears.
- 4 Press **▲/▼** repeatedly to select “Antenna Aiming,” then press **⊕**.
The Antenna Aiming screen appears.
- 5 While checking the quality of the reception, adjust the direction of the antenna to obtain the best reception.

To exit the menu

Press **MENU**.

Selecting a channel of the satellite radio

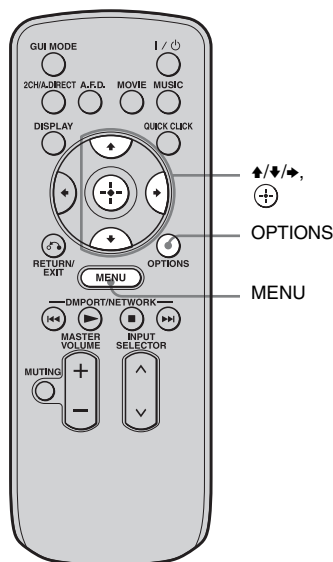

Tuning

Selecting a channel by category (Category Mode)

You can select a channel from one category or all the categories.

- 1 Press **MENU**.
The menu is displayed on the TV screen.
- 2 Press **▲/▼** repeatedly to select “**XM XM**” or “**SR SIRIUS**,” then press **⊕** or **➡**.
- 3 Press **OPTIONS**.
The option menu appears.
- 4 Press **▲/▼** repeatedly to select the category, then press **⊕**.
 - ALL: You can select a channel from all the categories.

continued

- (category name): You can select a channel from one category. When the “Preset Mode” screen is displayed, press **OPTIONS**, then press **▲/▼** repeatedly to select “Category Mode.”

5 Press **▲/▼** to select the channel, then press **⊕**.

The selected channel is being received. The channel information is displayed on the TV screen.

Note

When you select a channel in the “Category Mode,” the channel you selected may not be the one in the category you want. This is because one channel may belong to more than one category.

Selecting a channel by inputting the channel number directly (Direct Tuning)

Enter the channel number directly by using the numeric buttons on the multifunction remote. This operation cannot be performed using the simple remote.

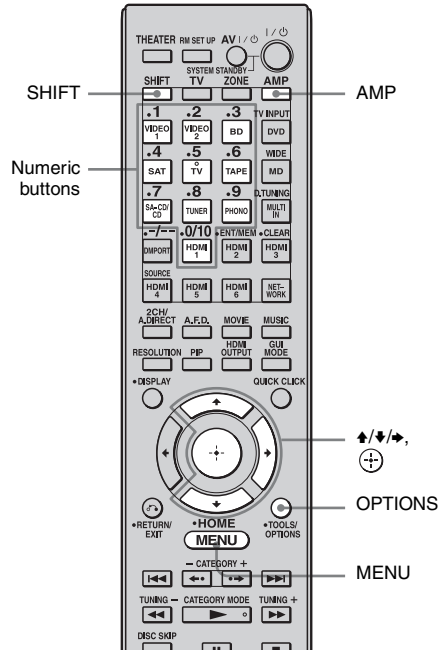

1 Press **AMP**.

The receiver can be operated using the remote.

2 Press **MENU**.

The menu is displayed on the TV screen.

3 Press **▲/▼** repeatedly to select “**XM XM**” or “**SR SIRIUS**,” then press **⊕** or **→**.

4 Press **OPTIONS**.

The option menu appears.

- 5 Press **▲/▼** to select “Direct Tuning,” then press **⊕**.
- 6 Press **SHIFT**, then press the numeric buttons to enter the channel number, then press **⊕**.
The selected channel is tune in.

Presetting satellite radio channels

You can select the channels you want directly by presetting them using the preset numbers. You can preset up to 30 XM Radio channels and 30 SIRIUS Satellite Radio channels.

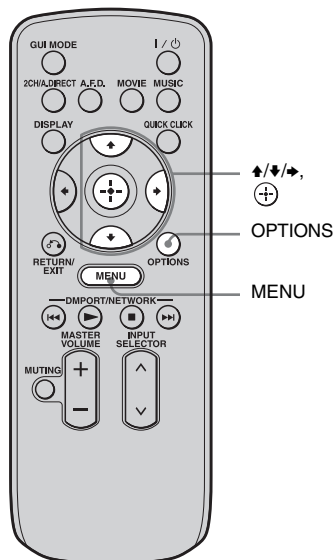

- 1 Select a channel you want to preset using **Category Mode** (page 75) or **Direct Tuning** (page 76).
- 2 Press **OPTIONS**.
The option menu appears.
- 3 Press **▲/▼** to select “Memory,” then press **⊕**.
The preset number selection screen appears.

- Press \uparrow/\downarrow repeatedly to select the preset number you want to use as the preset channel, then press \oplus .

Preset channels from 1 to 30 are available, and a default channel is preset for all the preset channels when you purchase the receiver.

The selected channel is registered as the preset channel you selected in step 1.

- Repeat steps 1 to 4 to preset another channel.

You can store channels from 1 to 30.

Selecting preset channels

- Press MENU.

The menu is displayed on the TV screen.

- Press \uparrow/\downarrow repeatedly to select “ \leftarrow XM XM” or “ \leftarrow SR SIRIUS,” then press \oplus or \rightarrow .

- Press \uparrow/\downarrow to select the preset number from the preset list, then press \oplus .

You can select stored preset channels from 1 to 30.

Notes

- The channel information you have preset may be changed if XM Satellite Radio Inc. or SIRIUS Satellite Radio Inc. change their channel programming.
- When the “Category Mode” screen is displayed, press OPTIONS, then press \uparrow/\downarrow to select “Preset Mode.”

Restricting access to specific channels (Parental Lock) (SIRIUS only)

You can restrict access to certain channels using your own lock code. The lock code is set to “0000” as the default. Use the multifunction remote for this operation. This operation cannot be performed using the simple remote. Change the lock code before you use this function for the first time. See “To change the lock code (Lock Code)” (page 79).

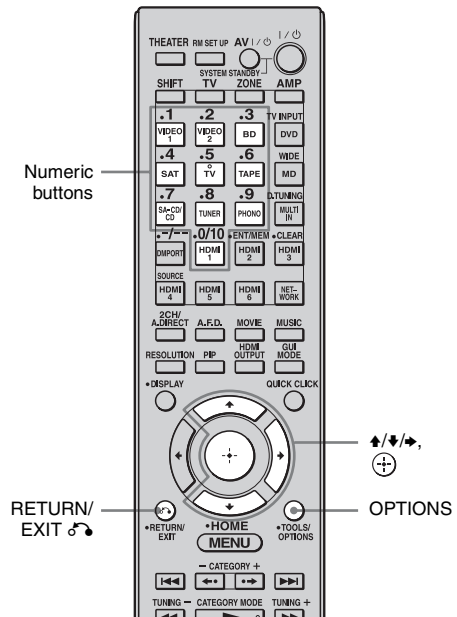

- Select a channel you want to lock using Category Mode (page 75) or Direct Tuning (page 76).

- Press OPTIONS.

The option menu appears.

- Press \uparrow/\downarrow to select “Parental Lock,” then press \oplus or \rightarrow .

4 Press **▲/▼** repeatedly to select “ON,” then press **⊕**.

“Enter your 4-digit lock code.” appears.

5 Enter your 4-digit lock code using the numeric buttons.

“The channel has been locked.” appears and the Parental Lock is set.

To delete the numbers you have entered, go back to step 2 by pressing RETURN/EXIT **↵**, and then repeat the procedure above from step 2.

To change the lock code (Lock Code)

1 Select any channel using Category Mode (page 75) or Direct Tuning (page 76).

2 Press **OPTIONS**.

The option menu appears.

3 Press **▲/▼** to select “Lock Code,” then press **⊕**.

“Enter your 4-digit lock code.” appears.

4 Enter your 4-digit lock code using the numeric buttons.

“Enter a new lock code.” appears.

5 Enter a new 4-digit lock code using the numeric buttons.

“To confirm, enter your new lock code again.” appears.

6 Reenter the new lock code with the numeric buttons.

“The lock code has been changed.” appears.

To listen to the locked channels

1 Select a locked channel you want to listen to using Direct Tuning (page 76).

“The channel is locked. Enter your 4-digit lock code.” appears.

2 Enter your 4-digit lock code using the numeric buttons.

The channel is tuned in.

To cancel the Parental Lock

1 Select a channel you want to unlock using Direct Tuning (page 76).

2 Press **OPTIONS**.

The option menu appears.

3 Press **▲/▼** to select “Parental Lock,” then press **⊕** or **➔**.

4 Press **▲/▼** repeatedly to select “OFF,” then press **⊕**.

“Enter your 4-digit lock code.” appears.

5 Enter your 4-digit lock code using the numeric buttons.

“The channel has been unlocked.” appears and the channel is unlocked.

Notes

- You can set only one lock code on the receiver. You cannot set individual lock codes for each channel.
- When you select a channel using Category Mode, locked channels are skipped.
- When the receiver is reset to the factory settings, the lock code returns to the default (0000), but the Parental Lock settings are not removed.
- You cannot preset locked channels. If you set the Parental Lock for a preset channel, the preset information for that channel returns to the default.
- You cannot set the Parental Lock for channel 0 or channel 184.

Message list

SIRIUS Satellite Radio message list

Message appears	Explanation	Remedies
Antenna Error	The antenna is not connected properly.	Check the connection between the SiriusConnect Home tuner and the antenna.
Acquiring Signal	The receiving condition is not good.	Try moving the antenna to another location. For details about the antenna location, refer to the instructions supplied with the SiriusConnect Home tuner.
Call 888-539-SIRI	You have not subscribed for the selected channel.	—
Check Sirius Tuner	The SiriusConnect Home tuner is not connected properly.	Check all the connections, and then turn the system on again. Also make sure if the AC adaptor supplied with the SiriusConnect Home tuner is connected to a wall socket.
Invalid Channel	You have entered an invalid channel number.	The channel to be tuned in is void due to the change by the broadcast service, or the receiving condition is not good.
Locked Channel	The selected channel is locked.	—
Subscription Updated	The subscription information has been updated.	—
Updating Channels ■■% Completed (■■ are for integers)	Channel information is being updated.	—
Firmware Updating	The SiriusConnect Home tuner firmware is being updated.	—
-----	There is no text information in the channel.	This is not an error. The text information may not be displayed depending on the system condition, for example, right after the system has received a channel.

XM Radio message list

Message appears	Explanation	Remedies
Check Antenna	The XM antenna is not connected to the XM Mini-Tuner Dock or the XM antenna cable is damaged.	Check that the XM antenna is securely connected to the XM Mini-Tuner Dock and check the antenna cable for damage. Replace the XM antenna if the cable is damaged.
CH Unauthorized	You selected an XM channel that is blocked or cannot be received with your XM subscription package.	Consult the latest channel guide at www.xmradio.com for the current list of channels. For information on receiving this channel, visit www.xmradio.com or contact XM Satellite Radio at 1-800-967-2346.
No Signal	The XM Mini-Tuner is not receiving the XM satellite signal. Something may be blocking the XM antenna's view of the satellites or the antenna is not properly aimed.	Check for antenna obstructions and reposition the XM antenna to get better signal reception. Use the Antenna Aiming option to optimize the antenna position (page 75). Refer to instructions supplied with the XM Mini-Tuner and Home Dock for antenna installation information.
Loading	The XM Mini-Tuner is acquiring audio or program information from the XM satellite signal. This message can also occur in weak XM signal conditions. Note that the receiver may not respond to some buttons while this message is displayed.	This message should disappear in a few seconds in good signal conditions. If you see this message often, reposition the XM antenna for better signal reception. Use the Antenna Aiming option to optimize the antenna position (page 75).
Off Air	You selected an XM channel is not currently broadcasting.	Check back later; in the mean time, select another channel.
(space)----	No artist name or song title is available for this selection.	No action required.
CH Unavailable	The selected channel is not available. The channel may have been reassigned to a different channel number. This message may occur initially with a new radio or a radio that has not received XM's signal for an extended period.	Consult the latest channel guide at www.xmradio.com for the current list of channels. For cases of a new radio or a radio that has not received XM's signal for an extended period, allow the radio to receive the XM satellite signal for at least 5 minutes and then try to select the channel again.
Check XM Tuner	The XM Mini-Tuner is not installed or not fully seated in the XM Mini-Tuner Dock or the XM Mini-Tuner dock is not connected to the receiver.	Confirm the XM Mini-Tuner is fully seated in the dock and check the XM Mini-Tuner dock cable is connected to the receiver.

Playing back with 2-channel sound

You can switch the output sound to 2-channel sound regardless of the recording formats of the software you are using, the playback component connected, or the sound field settings of the receiver.

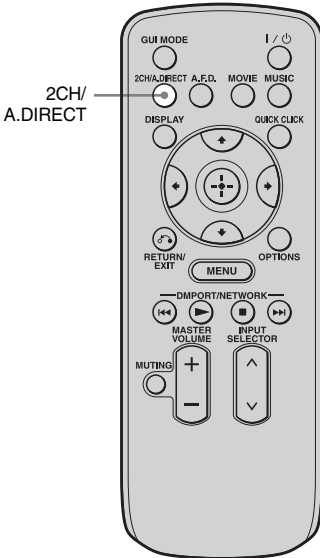

Press 2CH/A.DIRECT repeatedly to select the 2-channel sound mode of the sound output you want.

2CH mode	Effect
2ch Stereo	The receiver outputs the sound from the front left/right speakers only. There is no sound from the subwoofer. Standard 2 channel stereo sources completely bypass the sound field processing and multi-channel surround formats are downmixed to 2 channel.
2ch Analog Direct	You can switch the audio of the selected input to 2 channel analog input. This function enables you to enjoy high quality analog sources. When using this function, only the volume and front speaker balance can be adjusted.

Playing back with multi-channel surround

The Auto Format Direct (A.F.D.) mode allows you to listen to higher fidelity sound and select the decoding mode for listening to a 2 channel stereo sound as multi-channel sound.

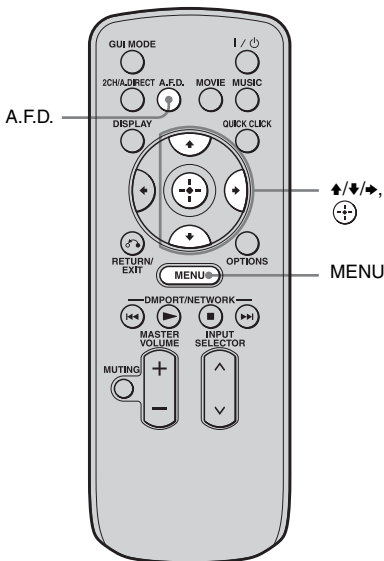

Press A.F.D. repeatedly to select the A.F.D. mode you want.

A.F.D. mode	Multi-channel audio after decoding	Effect
A.F.D. Auto	(Detecting automatically)	Presets the sound as it was recorded/encoded without adding any surround effects.
Enhanced Surround	—	You can select the surround sound effect you want. For details on available surround sound effects and how to set one, see “Setting a multi-channel surround sound effect” (page 84).
Multi Stereo	(Multi Stereo)	Outputs 2 channel left/right signals from all speakers.

Setting a multi-channel surround sound effect

1 Start playing a sound source you want to listen to (CD, DVD, etc.).

2 Press **MENU**.

The menu is displayed on the TV screen.

3 Press **▲/▼** repeatedly to select “**Settings**,” then press **⊕** or **➔**.

The Settings menu list appears on the TV screen.

4 Press **▲/▼** repeatedly to select “**Surround**,” then press **⊕** or **➔**.

5 Press **▲/▼** repeatedly to select “**Enhanced Sur Mode**,” then press **⊕**.

The menu for surround sound effect appears.

6 Press **▲/▼** repeatedly to select the **Enhanced Sur Mode** you want, then press **⊕**.

Enhanced Sur Mode	Multi-channel audio after decoding	Effect
Pro Logic II*	5-channel signals	Performs Dolby Pro Logic II mode decoding. A source recorded in 2 channel format is decoded into 5.1 channels. This setting is ideal for movies encoded in Dolby Surround. In addition, this mode can reproduce sound in 5.1 channel system for watching videos of overdubbed or old movies.
Pro Logic IIX*	7-channel signals	Performs Dolby Pro Logic IIX mode decoding. A source recorded in 2 channel or 5.1 channel format is decoded into 7.1 channels. This setting is ideal for movies encoded in Dolby Surround. In addition, this mode can reproduce sound in 7.1 channel system for watching videos of overdubbed or old movies.
Neo:6 Cinema	7-channel signals	Performs DTS Neo:6 Cinema mode decoding. A source recorded in 2 channel format is decoded into 7 channels.
Neo:6 Music	7-channel signals	Performs DTS Neo:6 Music mode decoding. A source recorded in 2 channel format is decoded into 7 channels. This setting is ideal for normal stereo sources such as CDs.
Neural-THX	7-channel signals	Next generation of Neural-THX® Surround. In addition to stereo enhancement processing and pure discrete 5.1 surround sound, now capable of full 360° 7.1 surround sound playback from Neural-THX® Surround encoded content.

* You can select “Pro Logic II” when there is no surround back speaker on the Speaker Pattern menu, or you can select “Pro Logic IIX” when there is a surround back speaker. You cannot select both settings at the same time.

Notes

- This function does not work when the multi-channel input is selected.
- Neural-THX is not effective when DTS-HD signals with a sampling frequency of 88.2 kHz and higher are being received.
- This function does not work when Dolby TrueHD signals with a sampling frequency of 176.4 kHz and higher are being received.
- The beginning of the sound stream may be dropped out when Neural-THX processing is turned on or off.

Tips

- We usually recommend “A.F.D. Auto.”
- You can identify the encoding format of DVD software, etc., by looking at the logo on the package.
- Dolby Pro Logic IIx decoding is effective, when 2 channel or 5.1 channel signals are input.
- Neural-THX is effective when 2 channel or 5.1 channel signals are input.

Enjoying a surround effect for music

You can take advantage of surround sound simply by selecting one of the receiver's pre-programmed sound fields. They bring the exciting and powerful sound of concert halls into your home.

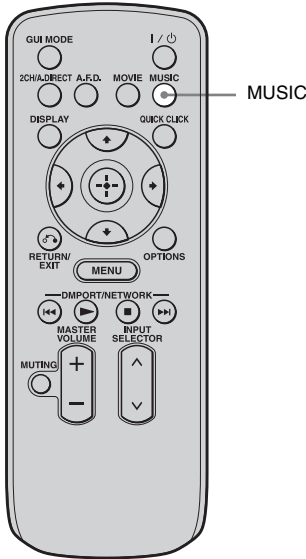

Press MUSIC repeatedly to select the surround effect you want for music.

Sound field	Effect
D.Concert Hall A	Uses 3D sound imaging to reproduce the sound characteristics of a concert hall, which simulates a large sound stage produced by reflectivity.
D.Concert Hall B	Uses 3D sound imaging to reproduce the sound characteristics of a concert hall, which simulates resonant and unique reverberative sound.
Jazz Club	Reproduces the acoustics of a jazz club.
Live Concert	Reproduces the acoustics of a 300-seat live house.
Stadium	Reproduces the feeling of a large open-air stadium.
Sports	Reproduces the feeling of sports broadcasting.
Portable Audio	Reproduces a clear enhanced sound image from your portable audio device. This mode is ideal for MP3 and other compressed music.

To listen to music through headphones connected to the receiver

Sound field	Effect
Headphone (2ch)	This mode is selected automatically if you use headphones when "2ch Stereo" mode or A.F.D. mode is selected. Standard 2 channel stereo sources completely bypass the sound field processing and multi-channel surround formats are downmixed to 2 channels.
Headphone (Direct)	Outputs the analog signals without processing by the tone, sound field, etc.
Headphone (Multi)	This mode is selected automatically if you use headphones when the multi-channel input is selected. Outputs the front analog signals from the MULTI CHANNEL INPUT jacks.

To turn off the surround effect for MUSIC

Press 2CH/A.DIRECT or A.F.D.

Notes

- The sound fields for music do not work when the multi-channel input is selected.
- The sound fields for music do not work when DTS-HD signals with a sampling frequency of 88.2 kHz and higher are being received.
- The sound fields for music do not work when Dolby TrueHD signals with a sampling frequency of 176.4 kHz and higher are being received.
- If you set up the sound field during DTS 96/24 signal reception, the signal will be played back only at 48 kHz.
- If you set up the sound field effect while the receiver is receiving signals with a sampling frequency of 88.2 kHz and higher, the signals will always be played back at either 44.1 kHz or 48 kHz.
- When one of the sound fields for music is selected, no sound is output from the subwoofer if all the speakers are set to "LARGE" in the Speaker settings menu. However, the sound will be output from the subwoofer if the digital input signal contains L.F.E. signals, or if the front or surround speakers are set to "SMALL," the sound field for movie is selected, or "Portable Audio" is selected.
- If there is any noise present, the noise may be different depending on the sound field you select.

Enjoying a surround effect for movies

You can take advantage of surround sound simply by selecting the receiver's preprogrammed HD-D.C.S. (HD Digital Cinema Sound) sound field. It brings the exciting and powerful sound of movie theaters into your home.

For details on HD-D.C.S. technology, see "Glossary" (page 180).

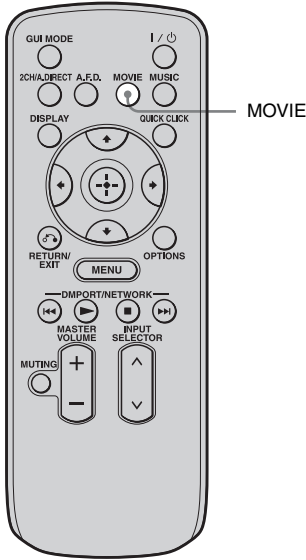

Press MOVIE.

Sound field	Effect
HD-D.C.S.	HD-D.C.S. can realize precisely sound effect on the movies watching through Blu-ray and DVD software, etc. like how Movie Sound Designers' intended to be. You can select the Effect Type for HD-D.C.S. For details, see "Sound Field Setup" (page 134).

To turn off the surround effect for MOVIE

Press 2CH/A.DIRECT or A.F.D.









Notes

- HD-D.C.S. does not work when the multi-channel input is selected.
- HD-D.C.S. does not work when DTS-HD signals with a sampling frequency of 88.2 kHz and higher are being received.
- HD-D.C.S. does not work when Dolby TrueHD signals with a sampling frequency of 176.4 kHz and higher are being received.
- If you set up the sound field during DTS 96/24 signal reception, the signal will be played back only at 48 kHz.
- If you set up the sound field effect while the receiver is receiving signals with a sampling frequency of 88.2 kHz and higher, the signals will always be played back at either 44.1 kHz or 48 kHz.
- If there is any noise present, the noise may be different depending on the sound field you select.

Digital audio formats supported by the receiver

Digital audio formats that this receiver can decode depend on digital audio input jacks for the components connected.

This receiver supports the following audio formats.

Audio format	Maximum number of channels	Connection of the playback component and the receiver	
		COAXIAL/OPTICAL	HDMI
Dolby Digital 	5.1ch	○	○
Dolby Digital EX 	6.1ch	○	○
Dolby Digital Plus ^{a)} 	7.1ch	×	○
Dolby TrueHD ^{a)} 	7.1ch	×	○
DTS 	5.1ch	○	○
DTS-ES 	6.1ch	○	○
DTS 96/24 	5.1ch	○	○
DTS-HD High Resolution Audio ^{a)} 	7.1ch	×	○
DTS-HD Master Audio ^{a) b)} 	7.1ch	×	○

Audio format	Maximum number of channels	Connection of the playback component and the receiver	
		COAXIAL/OPTICAL	HDMI
DSD ^{a)} DSD Direct Stream Digital	5.1ch	×	○
Multi channel Linear PCM ^{a)}	7.1ch	×	○

a) Audio signals are output in another format if the playback component does not correspond to the format. For details, refer to the operating instructions of the playback component.

b) Signals with a sampling frequency of 176.4 kHz and higher are played back at 96 kHz or 88.2 kHz.

About the network functions of the receiver

- The home network function of the receiver supports the DLNA (Digital Living Network Alliance) standard.
You can also enjoy content (music, photos, and videos) which have been stored on a DLNA-compliant device (DLNA CERTIFIED™ Products) that has an authorized DLNA logo displayed on the device.
- With an Internet connection, you can listen to Rhapsody and SHOUTcast and upgrade the firmware of the receiver. Rhapsody is only available in the US.

About DLNA

DLNA (Digital Living Network Alliance) is a standards organization made up of manufacturers of various products, such as computers, AV components, and mobile computing devices which exchange content (music, photos, and videos). DLNA decides upon standards and publishes an authorized logo to be displayed on devices which support DLNA standards.

What you can do with the home network function

You can do the following using the network function of the receiver.

Playing back content (music, photos, and videos) on devices on a home network

You can play back music, photos, and videos stored on other devices such as a computer on your home network using this receiver (page 96).

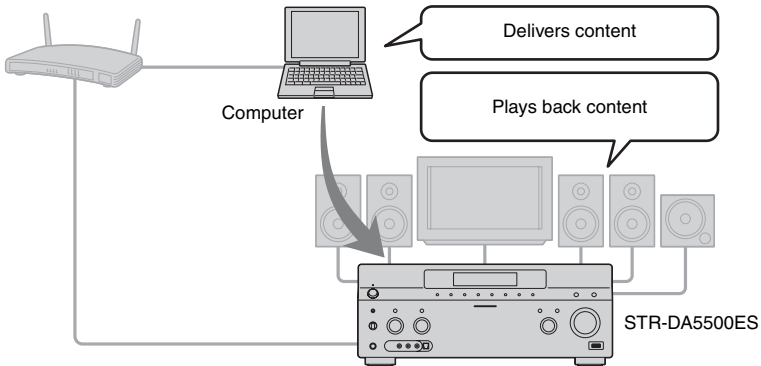

Listening to Rhapsody or SHOUTcast over the Internet

You can listen to Rhapsody or SHOUTcast using the receiver (page 98, 101). Rhapsody is only available in the US.

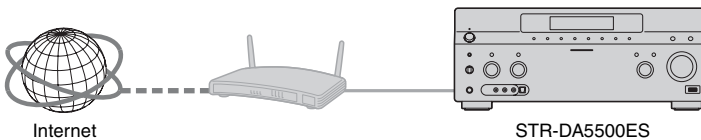

Other features

Changing the settings using a computer

You can change the settings of the receiver using a computer on your home network (page 103).

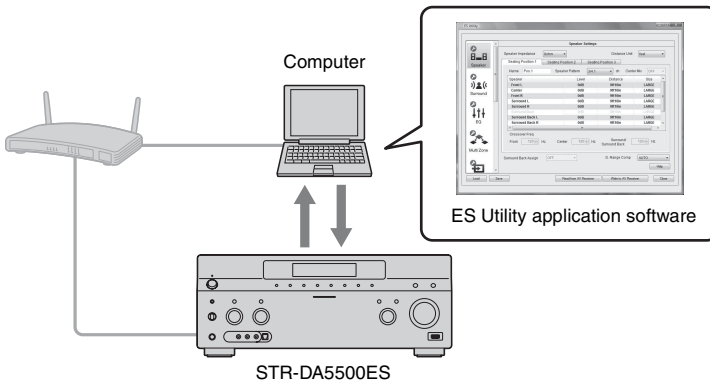

Firmware update

You can update the firmware of the receiver over the Internet.

A) Update the firmware directly over the Internet (page 146)

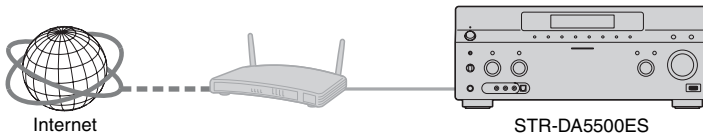

B) Update the firmware using a file downloaded from the Internet via a computer (page 103)

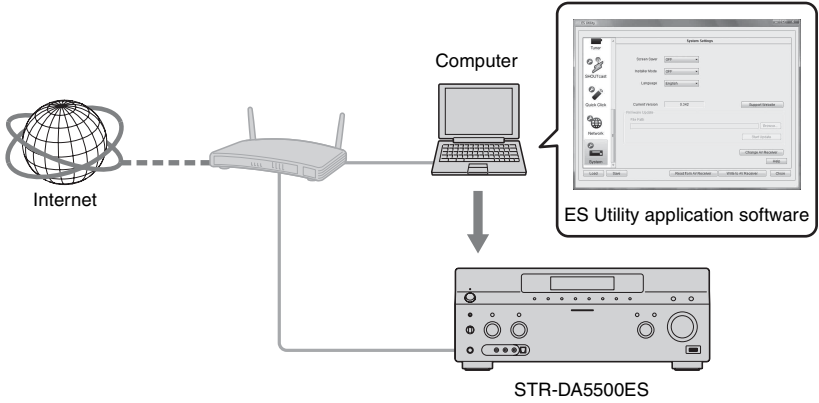

Enjoying content stored on the server

A server is a device which delivers content (music, photos, and videos) to a DLNA device on a home network.

You can play back music, photos, and videos stored on the server using the receiver.

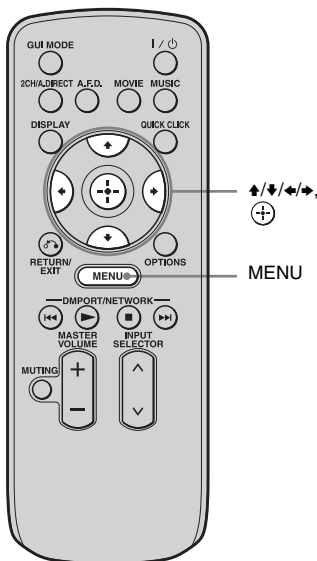
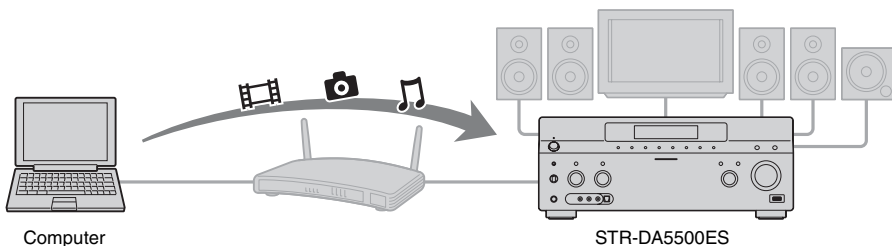

- 1 Press MENU.**
The menu is displayed on the TV screen.
- 2 Press \uparrow/\downarrow repeatedly to select “ 🎵 Music,” “ 📷 Photo,” or “ 🎬 Video,” then press ⊕ or ➡ .**

- 3 Press \uparrow/\downarrow repeatedly to select “Server,” then press ⊕ .**
The server list appears on the TV screen.











- 4 Press \uparrow/\downarrow and ⊕ to select the server which holds the content you want to play.**
The content list appears on the TV screen.

- 5 Press $\uparrow/\downarrow/\leftarrow/\rightarrow$ and ⊕ repeatedly to select content you want to play from the content list.**
The playback screen appears on the TV screen, and content you selected is played back.

Using the multifunction remote to play back content

You can enjoy content on the server by using the following buttons on the multifunction remote.

Press AMP to operate the receiver using the remote.

Content Type	 Music	 Photo	 Video
Remote button	●	●	●
	●	●	●
	●	●	●
	●	●	●
	●	●	
	●	●	
	●*		●*
	●*		●*

* This button may not work depending on the connected server or the content type.

Selecting the playback mode

You can select the playback mode of the Music category.

- 1 Press **OPTIONS** while listening to the music content.
- 2 Press **▲/▼** repeatedly to select “Repeat,” or “Shuffle,” then press **⊕**.
- 3 Press **▲/▼** repeatedly to select the mode you want to select from the following, then press **⊕**.

■ Repeat

Plays one or all the tracks repeatedly.

- Off
Deactivates the repeat play mode.
- One
Plays one track repeatedly.

- All
Plays all the tracks repeatedly.

■ Shuffle

Plays all the tracks in random order.

- Off
Deactivates the shuffle play mode.
- On
Activates the shuffle play mode.

Listening to Rhapsody

You can enjoy the Rhapsody Digital Music Service, without turning on a computer, by connecting your receiver to the internet. Rhapsody is only available in the US.

Rhapsody Digital Music Service

Play all the music you want with Rhapsody®

Thousands of artists. Millions of songs. Rhapsody is the critically-acclaimed digital music service that gives you unlimited access to a massive music catalog of millions of songs and thousands of artists. You'll also get exclusive content, personalized recommendations, DJ/ad-free listening on "Rhapsody Channels" and more. Try Rhapsody Now – Free 30 day Trial

For more information go to:
www.rhapsody.com/sonystr

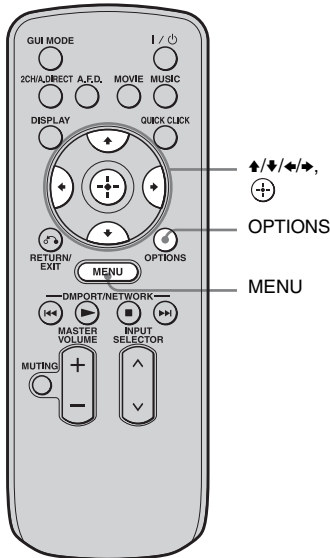

Setting an account

Before using the Rhapsody Digital Music Service, it is necessary to register an account using your computer.

Refer to www.rhapsody.com/sonystr for details.

Sign in using your account on the receiver.

- 1 Press MENU.**
The menu is displayed on the TV screen.
- 2 Press ↑/↓ repeatedly to select “Settings,” then press ⊕ or →.**
- 3 Press ↑/↓ repeatedly to select “Network,” then press ⊕ or →.**
- 4 Press ↑/↓ repeatedly to select “Rhapsody Account,” then press ⊕.**
The confirmation screen for account input appears on the TV screen.
- 5 Press ←/→ repeatedly to select “Yes,” then press ⊕.**
The account input screen appears on the TV screen.
- 6 Press ↑/↓ to select the user name box, then press ⊕.**
The soft keyboard appears on the TV screen.
- 7 Press ↑/↓/←/→ and ⊕ to select a character one by one to enter your user name.**
- 8 Press ↑/↓/←/→ repeatedly to select “Finish,” then press ⊕.**
- 9 Press ↑/↓ repeatedly to select the password box, then press ⊕.**

10 Press **▲/▼/◀/▶** and **⊕** to select a character one by one to enter your password.

11 Press **▲/▼/◀/▶** repeatedly to select “Finish,” then press **⊕**.

12 Press **▲/▼** repeatedly to select “Finish,” then press **⊕**.

Note

Repeat the process again from step 6 if the sign in fails.

To delete an account

1 Press MENU.

The menu is displayed on the TV screen.

2 Press **▲/▼** repeatedly to select “ Settings,” then press **⊕** or **▶**.

3 Press **▲/▼** repeatedly to select “Network,” then press **⊕** or **▶**.

4 Press **▲/▼** repeatedly to select “Rhapsody Account,” then press **⊕**.

5 Press OPTIONS to select “Remove Account,” then press **⊕**.

6 Press **◀/▶** repeatedly to select “Yes,” then press **⊕**.

The user name and the password are deleted.

Selecting the channel from the Rhapsody Channels list

You can select the channel you want to listen using the Rhapsody Channels list.

1 Press MENU.

The menu is displayed on the TV screen.

2 Press **▲/▼** repeatedly to select “ Rhapsody,” then press **⊕** or **▶**.

3 Press **▲/▼** repeatedly to select “Rhapsody Channels,” then press **⊕**.

4 Press **▲/▼/◀/▶** repeatedly to select the channel you want to listen to, then press **⊕**.

The reception screen appears on the TV screen and the channel you selected is received.

Note

You can listen to only the same channel in both the main zone and the 2nd zone.

Priority is given to the channel which has most recently been selected, even if other channel is currently being selected in one of zones.

Selecting the track using Music Guide

The Music Guide displays a variety of music selections to sample, including top tracks and artists, and recommendations.

Select genre names, charts, and new releases anywhere in the Music Guide pages to browse more.

1 Press MENU.

The menu is displayed on the TV screen.

2 Press **▲/▼** repeatedly to select “ Rhapsody,” then press **⊕** or **▶**.

3 Press **▲/▼** repeatedly to select “Rhapsody Music Guide,” then press **⊕**.

4 Press **▲/▼** repeatedly to select “Genres,” “Charts,” “New Releases,” or “Rhapsody Recommends,” then press **⊕**.

- 5 Press **▲/▼/◀/▶** to select the track you want to listen to from the list, then press **⊕**.

The playback screen appears on the TV screen and the track you selected is played back.

Note

You can listen to only the same track in both the main zone and the 2nd zone.

Priority is given to the track which has most recently been selected, even if other track is currently being selected in one of zones.

Searching for a track, album, or artist you want to listen to

You can search for a track, album, or artist using the search function.

- 1 Press **MENU**.
The menu is displayed on the TV screen.

- 2 Press **▲/▼** repeatedly to select “**Rhapsody**,” then press **⊕** or **▶**.

- 3 Press **▲/▼** repeatedly to select “**Search**,” then press **⊕**.

- 4 Press **▲/▼** repeatedly to select “**Artists**,” “**Albums**,” or “**Tracks**” you want to search for, then press **⊕**.

The soft keyboard appears on the TV screen.

- 5 Press **▲/▼/◀/▶** and **⊕** to select a character one by one to enter the title or name you want to search for.

- 6 Press **▲/▼/◀/▶** to select “**Finish**,” then press **⊕**.

Wait until the search result is displayed.

- 7 Press **▶** to select the search results.

- 8 Press **▲/▼/◀/▶** repeatedly to select the track you want to listen to from the search result, then press **⊕**.

The playback screen appears on the TV screen, and track you selected is played back.

Note

You can listen to only the same track in both the main zone and the 2nd zone.

Priority is given to the track which has most recently been selected, even if other track is currently being selected in one of zones.

Registering your favorite track, album, or channel

You can register your favorite track, album, or channel in “My Library” while playing back the track or during reception.

You can select the track, album or channel that you registered in “My Library” from “My Artists,” “My Albums,” “My Genres,” “My Tracks,” “My Playlists,” or “My Channels.”

- 1 Press **OPTIONS** while a track is playing back or you are selecting a channel.

- 2 Press **▲/▼** repeatedly to select “**Add track to My Library**,” “**Add album to My Library**,” or “**Add channel to My Library**,” then press **⊕**.

The track, album, or channel you chose will be registered in “My Library.”

To remove a track, album, or channel you registered

You can remove a track, album, or channel you registered in “My Library.”

- 1 Press **OPTIONS** while a track is playing back or you are selecting a channel.

- 2 Press **▲/▼** repeatedly to select “Delete album from My Library,” “Delete track from My Library,” or “Delete channel from My Library,” then press **⊕**.
The confirmation screen of deletion appears on the screen.
- 3 Press **◀/▶** repeatedly to select “Yes,” then press **⊕**.
The deletion is completed.

Selecting a track, playlist or channel you registered for My Library

You can select a track, playlist or channel you registered in “My Library.”

1 Press MENU.

The menu is displayed on the TV screen.

2 Press ▲/▼ repeatedly to select “Rhapsody,” then press ⊕ or ▶.

3 Press ▲/▼ repeatedly to select “My Library,” then press ⊕.

4 Press ▲/▼/◀/▶ to select the track you want to listen to using the My Library list, then press ⊕.

My Library list

- My Artists > *artist(s)** > *albums(s)** > *track(s)**
- My Albums > *album(s)** > *track(s)**
- My Genres > *genre(s)** > *artist(s)** > *album(s)** > *track(s)**
- My Tracks > *track(s)**
- My Playlists > *playlist(s)** > *track(s)**
- My Channels > *channel(s)**

*The number of lists displayed on the screen depends on the status of the Rhapsody Digital Music Service you are using.

The playback screen appears on the TV screen and the track you selected is played back.

Listening to SHOUTcast

SHOUTcast is a digital audio streaming technology-based radio service.

SHOUTcast is a directory of internet radio stations, allowing users to access thousands of free online radio stations from DJs and broadcasters around the world.

Refer to <http://www.shoutcast.com> for details.

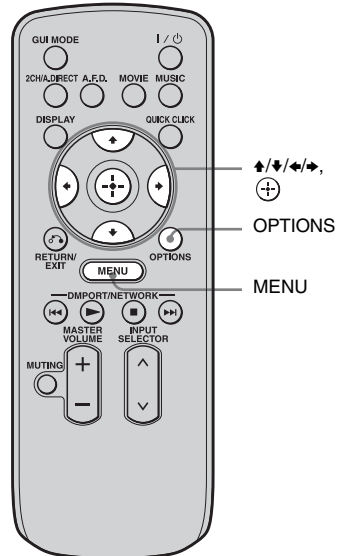

Selecting a SHOUTcast station

- 1 Press MENU.**

The menu is displayed on the TV screen.
- 2 Press \uparrow/\downarrow repeatedly to select “ SHOUTcast,” then press \oplus or \rightarrow .**
- 3 Press \uparrow/\downarrow repeatedly to select “Preset List,” “0-9,” or A to Z, then press \oplus .**
- 4 Press \uparrow/\downarrow repeatedly to select the genre you want to listen to, then press \oplus .**
- 5 Press $\uparrow/\downarrow/\leftarrow/\rightarrow$ to select the station you want to listen to, then press \oplus .**

The reception screen appears on the TV screen, and the station you selected is received.

Notes

- When the number of stations is large, up to 100 stations can be displayed (in order) on this receiver.
- The audio supplied in a format that is not supported by this receiver does not appear on the list.
- You can listen to only the same station in both the main zone and the 2nd zone.

Priority is given to the station which has most recently been selected, even if other station is currently being selected in one of zones.

Presetting favorite stations

You can register your favorite SHOUTcast stations on the receiver.

- 1 Press OPTIONS while listening to the radio station.**
- 2 Press \oplus to select “Add to Preset List.”**

The preset number list appears on the TV screen.

- 3 Press \uparrow/\downarrow repeatedly to select the preset number you want to preset, then press \oplus .**

Note

If you select a list number for which a station has already been registered, the previously registered station will be overwritten.

Tip

You can register one station for different list numbers.

To return to the previous screen

Press RETURN/EXIT .

Selecting preset stations

You can select your favorite stations from among the stations you registered.

- 1 Press MENU.**

The menu is displayed on the TV screen.
- 2 Press \uparrow/\downarrow repeatedly to select “ SHOUTcast,” then press \oplus or \rightarrow .**
- 3 Press \uparrow/\downarrow repeatedly to select “Preset List,” then press \oplus .**
- 4 Press \uparrow/\downarrow repeatedly to select the preset number station you want to listen to, then press \oplus .**

The reception screen appears on the TV screen, and the station you selected is received.

Features of the ES Utility application software

You can check the settings of the receiver, and adjust those settings using your computer, as well as using the receiver, after installing the ES Utility application software provided on the CD-ROM supplied with the receiver.

The following settings cannot be set using the computer with the ES Utility application software.

- Auto Calibration
 - Quick Setup
 - Enhanced Setup
- Speaker
 - Test Tone
- Multi Zone
 - Zone Power ON/OFF
 - Zone Input Change
 - Zone Volume Adjust

System Requirements

Operating System

Windows XP Home Edition/Professional/
Media Center Edition 2005 (SP3, 32 bit)
Windows Vista Home Basic/Home Premium/
Business/Ultimate (SP1, 32 bit/64 bit)

Computer

CPU: Celeron, Pentium III or higher
Clock Speed: 1 GHz or higher
RAM: 512 MB or more
HDD: 20 MB or more free disk space
(280 MB free disk space is required when
.NET Framework 2.0 is not installed.)
Monitor: 1024 × 768, High Color
(65536 colors)
Network: 100Base-TX or higher

Installing the ES Utility application software on a computer

- 1 Turn on your computer and login as an administrator.**
- 2 Insert the supplied CD-ROM into the CD-ROM drive of your computer.**

The installation launcher starts automatically, then a Software Setup screen appears on the screen.

If the installation launcher does not start automatically, double-click “SetupLauncher.exe” on the disc.

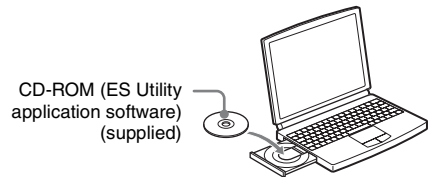

- 3 Install the ES Utility application software following the instructions given in the message on the screen.**

Updating the receiver firmware using the ES Utility

You can update the receiver firmware using the ES Utility application software provided on the CD-ROM supplied with the receiver. Refer to the HELP of the ES Utility for details on operations of the ES Utility.

- 1 Download the update program from the support website on the computer to which you installed the ES Utility.**

- 2 Press MENU.**

The menu is displayed on the TV screen.

3 Press **▲/▼** repeatedly to select “**Settings**,” then press **⊕** or **➔**.

4 Press **▲/▼** repeatedly to select “**System**,” then press **⊕** or **➔**.

5 Press **▲/▼** repeatedly to select “**System Update**,” then press **⊕**.

6 Press **▲/▼** repeatedly to select “**PC Update**,” then press **⊕**.

A confirmation screen appears on the TV screen.

7 Press **▲/▼** repeatedly to select “**Start**,” then press **⊕**.

The status of waiting for the data from the PC is displayed on the TV screen.

8 Click “**System**” in the ES Utility window on the computer screen, then click “**Browse...**” and specify the path of the update program, and click “**Start Update**.”

Receiver updating starts.

When updating complete, the receiver will restart automatically.

Notes

- Do not turn the receiver off or disconnect the network cable during firmware updating. It may cause a malfunction.
- It may take 30 minutes for the firmware updating to complete.

To check the HELP

When you want to check the HELP of the ES Utility application software, click [Start] – [All Programs] – [ES Utility] – [Help for ES Utility], in that order.

What you can do with the Multi-zone function

You can enjoy images and sounds from a component connected to the receiver in a zone other than the main zone. For example, you can watch the DVD in the main zone and listen to the CD in zone 2 or zone 3.

When using an IR repeater (not supplied), you can operate both a component in the main zone and Sony receiver in zone 2 or zone 3 from zone 2 or zone 3.

Use the multifunction remote in zone 2 or zone 3. You cannot use the simple remote in a zone (zone 2 or zone 3) other than the main zone.

To operate the receiver from zone 2 or zone 3

You can operate the receiver without pointing the remote toward the IR repeater of the receiver if you connect an IR repeater (not supplied) to the IR REMOTE jack.

Use an IR repeater when you install the receiver in a place where signals from the remote cannot reach.

Making a multi-zone connection

1:Zone 2 connections

- ① Outputs sound from speakers in zone 2 using the SURROUND BACK SPEAKERS terminals of the receiver.

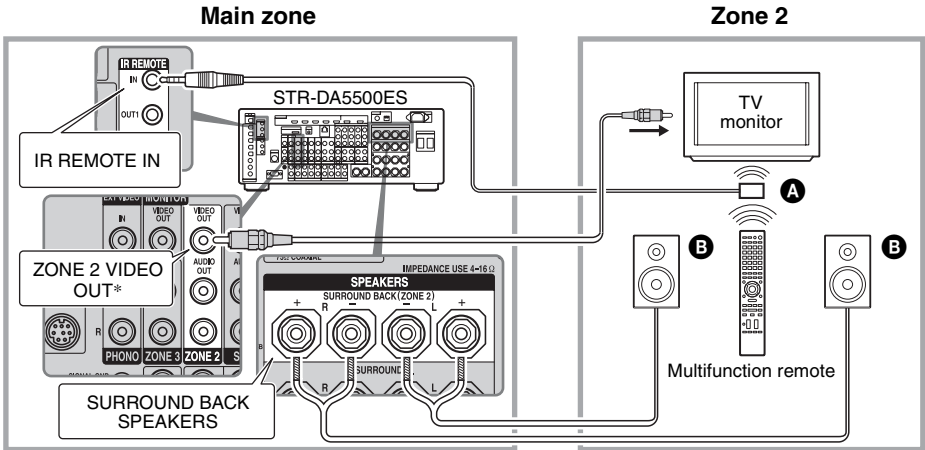

- ② Outputs sound from speakers in zone 2 using the receiver and another amplifier.

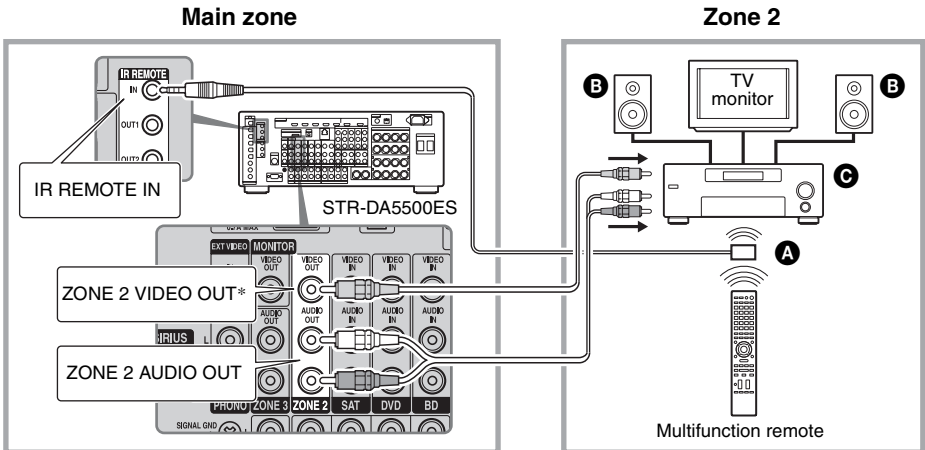

A IR repeater (not supplied)

B Speakers

C Sony Amplifier/Receiver

* You can also connect to the COMPONENT VIDEO ZONE 2 OUT jack.



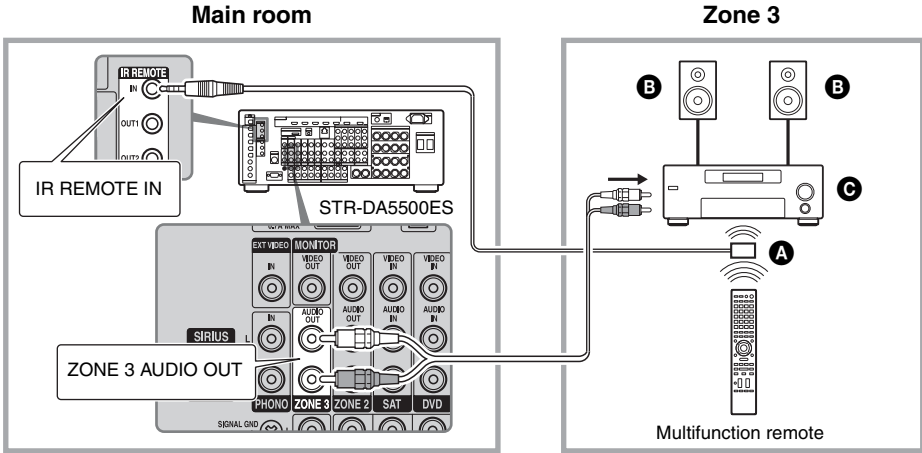

2:Zone 3 connections



- A** IR repeater (not supplied)
- B** Speakers
- C** Sony Amplifier/Receiver





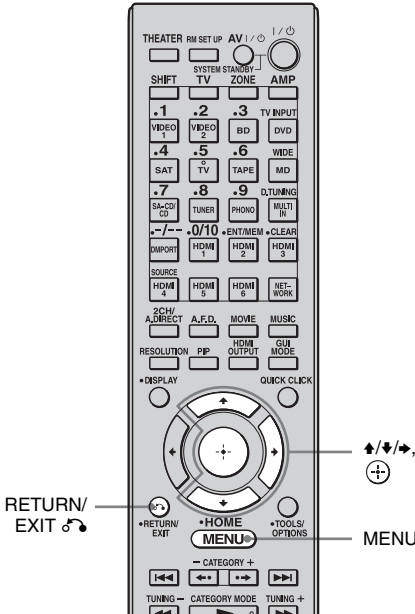

Setting the speakers in zone 2

When the speakers in zone 2 are connected to the SURROUND BACK SPEAKERS terminals of the receiver (page 106), make the setting so that the sound selected in zone 2 is output from the speakers connected to the SURROUND BACK SPEAKERS terminals.

- 5 Press RETURN/EXIT .
- 6 Press  repeatedly to select “Sur Back Assign,” then press .
- 7 Press  to select “ZONE2,” then press .

To exit the menu
Press MENU.



- 1 Press MENU.
The menu is displayed on the TV screen.
- 2 Press  repeatedly to select “Settings,” then press  or .
- 3 Press  repeatedly to select “Speaker,” then press  or .
- 4 Press  to select “Speaker Pattern,” to select the pattern that has no surround back speakers.

Switching the zone setting of the remote

The remote commander is initially set to be used in zone 2. If you want to use it in zone 3, switch the zone setting of the remote.

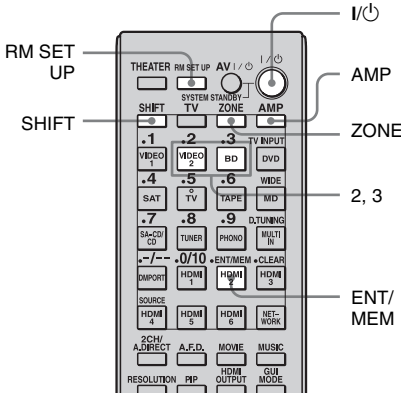

1 Press I/O while pressing RM SET UP.

The AMP and ZONE buttons flash.

2 Press ZONE.

The AMP button goes off, the ZONE button keeps flashing and the SHIFT button lights up.

3 Press the numeric button 2 for the zone 2, or 3 for the zone 3 while the ZONE button is flashing.

The ZONE button lights up.

4 Press ENT/MEM.

The ZONE button flashes twice and the remote switches to zone 2 or zone 3 mode.

Operating the receiver from another zone (ZONE 2/ZONE 3 operations)

The following operations are described for connecting an IR repeater and operating the receiver in zone 2 or zone 3. When an IR repeater is not connected, use this receiver in the main zone.

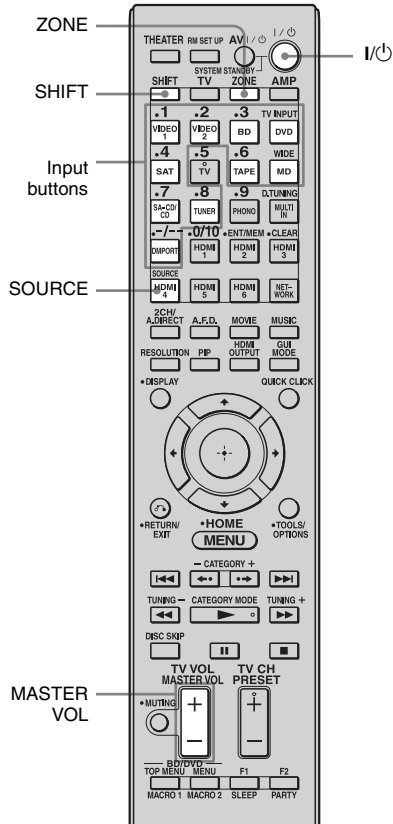

1 Turn on the main receiver (this receiver) and the amplifier in zone 2 or zone 3.

2 Press ZONE.

The remote switches to zone 2 or zone 3. Change the zone setting of the remote to zone 2 or zone 3 in advance (page 109).

3 Press I/⏻.

The zone function is activated.

4 Press one of the input buttons on the remote to select the source signals you want to output.

For zone 2, analog video and audio signals are output. For zone 3, only analog audio signals are output. When you select SOURCE, the signals of the current input are output.

5 Adjust to a suitable volume.

- In the case of illustration 1-① (page 106), adjust the volume using MASTER VOL +/- on the remote.
- In the case of illustration 1-② (page 106), adjust the volume using the receiver in zone 2 or zone 3.

To finish the zone 2/zone 3 operation

Press I/⏻ after pressing ZONE.

Tips

- Even when this receiver is standby mode (press I/⏻ on the remote to turned off this receiver), the receiver in zone 2 or zone 3 remains turned on. To turn off all receivers, press I/⏻ and AV I/⏻ on the multifunction remote at the same time (SYSTEM STANDBY).
- Only signals from components connected to the analog input jacks are output through the ZONE 2 or ZONE 3 jacks. No signals are output from components connected to only the digital input jacks.
- When SOURCE is selected, the signals input to the MULTI CHANNEL INPUT jacks are not output from the ZONE 2 OUT or ZONE 3 OUT jacks even when the multi-channel input is selected. The analog audio signals of the current function are output.

Listening to the same music in different zone (Party Mode)

You can enjoy listening to the same music in different zone.

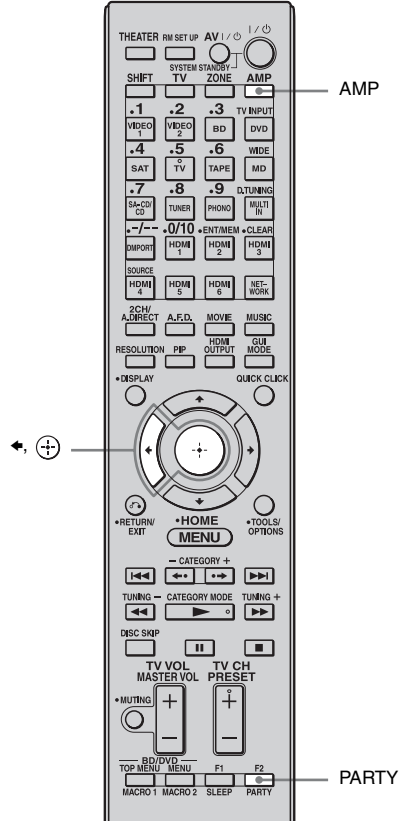

1 Start playback in the main zone.

2 Press AMP.

3 Press PARTY.

The party mode screen appears on the TV screen.

4 Press **←** to select “Start,” then press **⊕**.

The same sound of the input selected in main zone is output in the zone selected in party mode (page 138).

To exit the party mode

Select other input in zone 2 or zone 3.

See “Operating the receiver from another zone (ZONE 2/ZONE 3 operations)” (page 109) for details of the operation of zone2 /zone 3.

Using Other Features

Using “BRAVIA” Sync features

What is “BRAVIA” Sync?

“BRAVIA” Sync is compatible with a Sony TV, Blu-ray Disc/DVD player, AV amplifier, etc., that is equipped with the Control for HDMI function.

By connecting Sony components that are compatible with the “BRAVIA” Sync with a HDMI cable (not supplied), operation is simplified as below:

- One-Touch Play (page 114)
- System Audio Control (page 114)
- System Power-Off (page 115)
- Theater Mode Sync (page 115)
- 24p Auto Sound Sync (page 115)

Control for HDMI is a mutual control function standard used by HDMI CEC (Consumer Electronics Control) for HDMI (High-Definition Multimedia Interface).

The Control for HDMI function does not work in the following cases:

- When you connect the receiver to a component which is not correspond with Sony Control for HDMI function.
- When you connect the receiver and components using other than HDMI connection.
- The Control for HDMI function does not work on a component connected to the HDMI OUT B jack of the receiver.

We recommend that you connect the receiver to products featuring “BRAVIA” Sync.

Note

Depending on the connected component, the Control for HDMI function may not work. Refer to the operating instructions of the component.

Preparing for the “BRAVIA” Sync

To use the “BRAVIA” Sync, turn the Control for HDMI function on for both the receiver and the connected component. The receiver is compatible with the “Control for HDMI-Easy Setting” function.

When your TV is compatible with the “Control for HDMI-Easy Setting” function

When you connect a Sony TV with the “Control for HDMI-Easy Setting” function, the Control for HDMI function of the receiver can be turned on simultaneously by turning the Control for HDMI function of the TV on.

- 1** Make sure that the receiver, TV, and playback components are connected using an HDMI cable (not supplied). (The respective components must be compatible with the Control for HDMI function.)
- 2** Turn on the receiver, TV and playback components.
- 3** Turn the Control for HDMI function of the TV on.
The Control for HDMI function of the receiver and all the connected components are simultaneously turned on. During setup, “SCANNING” appears in the display window of the receiver, and once setting is completed, “COMPLETE” will appear. Wait until the setup is complete.

For details on setup of the TV, refer to the operating instructions of your TV.

Notes

- When you pull out the HDMI cable or change the connection, perform the steps given in “When your TV is compatible with the “Control for HDMI-Easy Setting” function” (page 112) or “When your TV is not compatible with the “Control for HDMI-Easy Setting” function.”
However, you do not need to perform these steps when you use an HDMI IN 1, IN 2, or IN 6 jack.
- When you assign the component video input to the HDMI input using the Input Assign function, you cannot set “Control for HDMI” to “ON.”
- While “Control for HDMI-Easy Setting” is being set, you cannot use functions such as One-Touch Play or System Audio Control.
- When you set up the receiver using the “Control for HDMI-Easy Setting” from a TV, turn on the TV, the receiver and the playback components beforehand.
- When you set up the receiver using the “Control for HDMI-Easy Setting” from a TV, before you make the “Control for HDMI-Easy Setting” function effective, make the Control for HDMI function of the components that are not compatible with the “Control for HDMI-Easy Setting” function effective.

When your TV is not compatible with the “Control for HDMI-Easy Setting” function

Turn the Control for HDMI function of the receiver and the connected component on individually.

Use the multifunction remote for this operation. This operation cannot be performed using the simple remote.

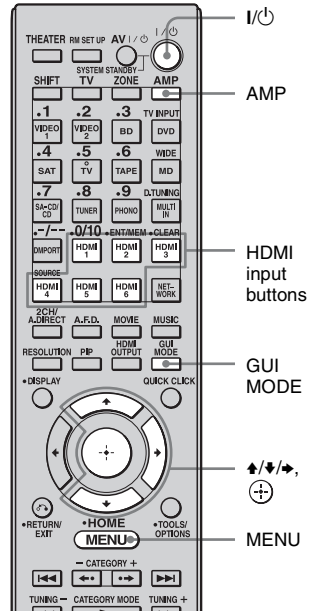

- 1 Perform the steps given in “When your TV is compatible with the “Control for HDMI-Easy Setting” function” (page 112).
- 2 Press AMP.
The receiver can be operated using the remote.
- 3 Press MENU.
The menu is displayed on the TV screen.
- 4 Press \uparrow/\downarrow repeatedly to select “Settings,” then press \oplus or \rightarrow .
- 5 Press \uparrow/\downarrow repeatedly to select “HDMI,” then press \oplus or \rightarrow .

- 6 Press $\blacktriangle/\blacktriangledown$ repeatedly to select “Control for HDMI,” then press \oplus or \blacktriangleright .
- 7 Press $\blacktriangle/\blacktriangledown$ repeatedly to select “ON,” then press \oplus .
The Control for HDMI function of the receiver is activated.
- 8 Press GUI MODE to exit the GUI menu. If the GUI menu is displayed, the Control for HDMI function of the playback components will not work properly.
- 9 Press one of the HDMI input buttons to display the image of the playback components for which you want to set the Control for HDMI function.
- 10 Turn the Control for HDMI function of the connected component on.
For details on setting the connected component, refer to its operating instructions.
- 11 Repeat steps 9 and 10 to set the Control for HDMI function and to display the image of all the playback components you want to use.

Playing back components with one-touch operation (One-Touch Play)

By a simple operation (one-touch), components connected to the receiver with HDMI connections start automatically. You can enjoy the sound/image using connected components.

When you set “Pass Through” to “AUTO” or “ON,” sound and image can be output only from the TV while the receiver remains in standby mode.

Play back a connected component.

The receiver and TV are turned on simultaneously, and sound and image are output from the receiver and TV.

To use the One-Touch Play of the camcorder

- 1 Turn the Control for HDMI function on for both the receiver and your camcorder.
- 2 Connect your camcorder to the HDMI IN 1, IN 2, or IN 6 jack (page 33).
The receiver and TV are turned on simultaneously, and sound and image are output from the receiver and TV.

Notes

- Connect your camcorder to the HDMI IN 1, IN 2, or IN 6 jack. The camcorder may not work correctly if you connect it to the HDMI IN 3, IN 4, or IN 5 jack.
- Depending on the TV, the start of the content may not be output.

Enjoying the TV sound from the speakers connected to the receiver (System Audio Control)

You can enjoy the TV sound from the speakers connected to the receiver by a simple operation.

Depending on the TV settings, while you are watching the TV, the receiver turns on and switches to the “TV” function automatically. TV sound is output from the speakers connected to the receiver, and the volume of the TV is minimized simultaneously.

You can use the System Audio Control function as follows.

- The sound of the TV is output from the speakers connected to the receiver when you turn the receiver on while the sound is being output from the TV speaker.
- You can adjust the receiver’s volume when you adjust the TV volume.

You can also operate this function using the TV menu. For details, refer to the operating instructions of the TV.

Notes

- When “Control for HDMI” is set to “ON,” the “Audio Out” settings in the HDMI settings menu will set automatically depending on the System Audio Control settings.
- When you connect a TV that does not have System Audio Control function, the System Audio Control function does not work.
- If the TV is turned on before turning on the receiver, the TV sound will not be output for a moment.

Turning off the receiver with the TV (System Power-Off)

When you turn the TV off by using the power button on the TV’s remote, the receiver and the connected components turn off automatically.

You can also use the multifunction remote to turn off the TV.

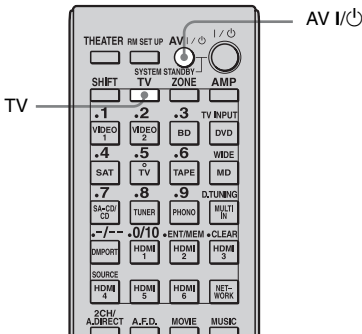

Press TV, then press AV I/O.

The TV, receiver and connected components are turned off.

Notes

- Set the TV power supply interlock function to on before using the System Power Off function. For details, refer to the operating instructions of the TV.
- Depending on the status, the connected components may not be turned off. For details, refer to the operating instructions of the connected components.

Enjoying movies with the optimum sound field (Theater Mode Sync)

Press the THEATER button on the remote of the receiver, TV, or the Blu-ray Disc Player, while pointing the remote toward the TV.

The sound field switches to HD-D.C.S.

To return to the previous sound field, press the THEATER button again.

Note

The sound field may not switch depending on the TV.

Tip

The sound field may be changed back to the previous one when you change the TV’s input.

24p Auto Sound Sync

This function switches the sound field to HD-D.C.S. automatically when 24p (24 frames per second) signals are input from a playback component, such as a Blu-ray Disc Player.

Play back content containing 24p signals on a playback component.

The sound field switches to HD-D.C.S.

If you do not want the sound field to switch to HD-D.C.S. automatically, set “24p Auto Sound Sync” to “OFF” (page 143).

Notes

- This function does not work if a player is not compatible with 24p Auto Sound Sync.
- When “Control for HDMI” is set to “ON,” depending on the player, the sound field may not switch to HD-D.C.S.

When “Control for HDMI” is set to “ON,” the receiver detects the 24p signals via “BRAVIA” Sync. Therefore, if a player that is not compatible with “BRAVIA” Sync sends out 24p signals, the receiver will not switch the sound field to HD-D.C.S. In this case, set “Control for HDMI” to “OFF.” When “Control for HDMI” is set to “OFF,” the receiver detects the 24p signals by itself.

Switching the monitors that output the HDMI video signals

When you have two monitors connected to the HDMI OUT A and HDMI OUT B jacks, you can switch the output for these two monitors using the HDMI OUTPUT button on the multifunction remote. This operation cannot be performed using the simple remote.

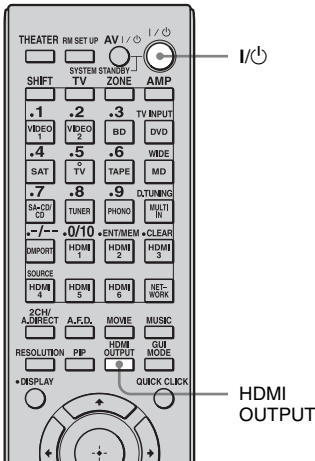

- 1 Turn on the receiver and the two monitors.**
- 2 Press HDMI OUTPUT.**

Each time you press the button, the output will be switched as follows:
 HDMI A → HDMI B → HDMI A + B → OFF → HDMI A...

You can also use the HDMI OUT button on the receiver.

Notes

- If the compatible video format differs between the monitors connected to the HDMI OUT A jack and the HDMI OUT B jack of the receiver, “HDMI A + B” may not work.
- Depending on the playback component you connect, “HDMI A + B” may not work.

Outputting the HDMI signals even when the receiver is in standby mode (Pass Through)

You can output the video and audio signals from the HDMI IN jack to the TV connected to the HDMI OUT jack even when the receiver is in standby mode.

When you activate this function, make the settings for “Pass Through” following the settings below.

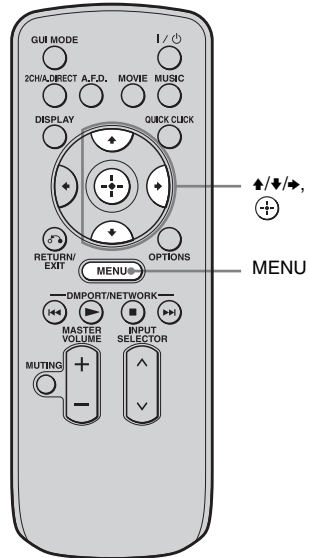

- 1 Press MENU.**
The menu is displayed on the TV screen.
- 2 Press ↑/↓ repeatedly to select “Settings,” then press ⊕ or ▶.**
- 3 Press ↑/↓ repeatedly to select “HDMI,” then press ⊕ or ▶.**

4 Press \uparrow/\downarrow repeatedly to select “Pass Through,” then press \oplus or \rightarrow .

5 Press \uparrow/\downarrow repeatedly to select the parameter you want, then press \oplus or \rightarrow .

Parameter	Explanation
AUTO	When the TV is turned on while the receiver is in the standby mode, the receiver outputs HDMI signals from the receiver’s HDMI OUT A jack. Sony recommends this setting if you use a TV that is compatible with “BRAVIA” Sync. This setting saves power in the standby mode compared with the “ON” setting.
ON	When the receiver is in the standby mode, the receiver continuously outputs HDMI signals from the receiver’s HDMI OUT A jack.
OFF	The receiver does not output HDMI signals when in the standby mode. Turn on the receiver to enjoy the connected component’s source on the TV. This setting saves power in the standby mode, compared with the “ON” setting.

Notes

- This function does not work when you set “Control for HDMI” to “OFF.”
- This function is available only when you select “HDMI A” or “HDMI A + B” using the HDMI OUTPUT button. When you select “HDMI B” or “OFF,” this function does not work.
- When “AUTO” is selected, it may take a little more time for the picture and sound to be output to the TV than when “ON” is selected.

Switching between digital and analog audio

When you connect components to both digital and analog audio input jacks on the receiver, you can fix the audio input mode to either of them, or switch from one to the other, depending on the type of material you intend to watch.

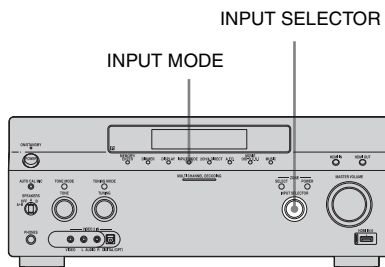

1 Select the input source using **INPUT SELECTOR** on the receiver.

2 Press **INPUT MODE** on the receiver.

The selected audio input mode appears on the TV screen.

- Auto
Gives priority to digital audio signals when there are both digital and analog connections.
If there are no digital audio signals, analog audio signals are selected.
- Analog
Specifies the analog audio signals input to the AUDIO IN (L/R) jacks.

Notes

- Some audio input modes may not be set up depending on the input.

- When either the HDMI input, DIGITAL MEDIA PORT adapter, Server, Rhapsody, SHOUTcast, XM, or SIRIUS is selected, “-----” appears on the display, and you cannot select other modes. Select an input other than the HDMI input, DIGITAL MEDIA PORT adapter, Server, Rhapsody, SHOUTcast, XM, or SIRIUS then set the audio input mode.
- When “2ch Analog Direct” is being used, or the multi-channel input is selected, audio input is set to “Analog.” You cannot select other modes.

Enjoying the sound/ images from other inputs (Input Assign)

You can reassign video and/or audio signals to another input.

Example) Connect the OPTICAL OUT jack of the DVD player to the OPTICAL VIDEO 1 IN jack of this receiver when you want to input the only digital optical audio signals from the DVD player.

Connect the component video jack of the DVD player to the COMPONENT VIDEO IN 1/ COMPONENT VIDEO IN 2, or COMPONENT VIDEO IN 3 jack of this receiver when you want to input the video signals from the DVD player. Assign video and/or audio signals to the DVD input jack using “Input Assign” in the Input menu.

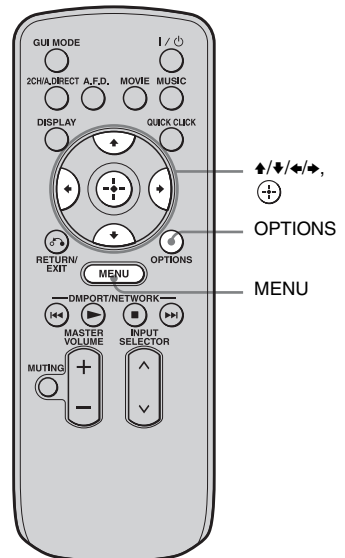

1 Press MENU.

The menu is displayed on the TV screen.

- 2** Press **↑/↓** repeatedly to select “**Input**,” then press **⊕** or **→**.
- 3** Press **↑/↓** to select the input name you want to assign.
- 4** Press **OPTIONS**.
The option menu appears.
- 5** Press **↑/↓** to select “**Input Assign**,” then press **⊕**.
- 6** Press **↑/↓/←/→** to select the audio and/or video signals you want to assign to the input selected in step 3, then press **⊕**.

Input name		VIDEO1	VIDEO2	BD	DVD	SAT	TAPE	MD	SA-CD/ CD	MULTI IN	HDMI1	HDMI2	HDMI3	HDMI4	HDMI5	HDMI6	
Assignable video input jacks	Video1 Composite	○ ^{a)}	-	-	-	-	-	-	-	-	-	-	-	-	-	-	
	Video2 Composite	-	○ ^{a)}	-	-	-	-	-	-	-	-	-	-	-	-	-	
	BD Composite	-	-	○	-	-	-	-	-	-	-	-	-	-	-	-	
	DVD Composite	-	-	-	○	-	-	-	-	-	-	-	-	-	-	-	
	SAT Composite	-	-	-	-	○	-	-	-	-	-	-	-	-	-	-	
	Component1	○	○	○ ^{a)}	○	○	○	○	○	○	○ ^{b)}	○ ^{b)}	○ ^{b)}	○ ^{b)}	○ ^{b)}	○ ^{b)}	○ ^{b)}
	Component2	○	○	○	○ ^{a)}	○	○	○	○	○	○ ^{b)}	○ ^{b)}	○ ^{b)}	○ ^{b)}	○ ^{b)}	○ ^{b)}	○ ^{b)}
	Component3	○	○	○	○	○ ^{a)}	○	○	○	○	○ ^{b)}	○ ^{b)}	○ ^{b)}	○ ^{b)}	○ ^{b)}	○ ^{b)}	○ ^{b)}
	HDMI1	○	○	○	○	○	○	○	○	○	○ ^{a)}	-	-	-	-	-	-
	HDMI2	○	○	○	○	○	○	○	○	○	-	○ ^{a)}	-	-	-	-	-
	HDMI3	○	○	○	○	○	○	○	○	○	-	-	○ ^{a)}	-	-	-	-
	HDMI4	○	○	○	○	○	○	○	○	○	-	-	-	○ ^{a)}	-	-	-
HDMI5	○	○	○	○	○	○	○	○	○	-	-	-	-	○ ^{a)}	-	-	
HDMI6	○	○	○	○	○	○	○	○	○	-	-	-	-	-	-	○ ^{a)}	
Assignable audio input jacks	Video1 OPT	○ ^{a)}	-	○	○	-	-	-	○	-	-	-	-	-	-	-	-
	Video2 OPT	-	○ ^{a)}	○	○	-	-	-	○	-	-	-	-	-	-	-	-
	SAT OPT	-	-	○	○	○ ^{a)}	-	-	○	-	-	-	-	-	-	-	-
	Tape OPT	-	-	○	○	-	○ ^{a)}	-	○	-	-	-	-	-	-	-	-
	MD OPT	-	-	○	○	-	-	○ ^{a)}	○	-	-	-	-	-	-	-	-
	BD COAX	○	○	○ ^{a)}	-	○	○	○	-	-	-	-	-	-	-	-	-
	DVD COAX	○	○	-	○ ^{a)}	○	○	○	-	-	-	-	-	-	-	-	-
SA-CD/CD COAX	○	○	-	-	○	○	○	○ ^{a)}	-	-	-	-	-	-	-	-	

^{a)}Initial setting

^{b)}When you assign a component video input to the HDMI input via the Input Assign menu, component video signals are not converted to HDMI video signals and are not output from the HDMI OUT jacks. Component video signals are output from the COMPONENT VIDEO MONITOR OUT jack. In this case, the resolution of the GUI output is set to “480p” for both component video input and HDMI video input.

Notes

- You cannot assign optical signals from an input source to the optical input jacks on the receiver, and you cannot assign coaxial signals from the input source to the coaxial input jacks on the receiver.
- When you assign the digital audio input, the INPUT MODE setting may change automatically.
- You cannot reassign more than one HDMI input to the same input.

- You cannot reassign more than one digital audio input to the same input.
- You cannot reassign more than one component video input to the same input.
- When you assign a component video input to the HDMI input, set “Control for HDMI” to “OFF.”

Using the sleep timer

You can set the receiver to turn off automatically at a specified time. Use the multifunction remote for this operation. This operation cannot be performed using the simple remote.

0:30:00 → 1:00:00 → 1:30:00 → 2:00:00 → OFF

When sleep timer is being used, “SLEEP” lights up in the display window of the receiver.

Tip

To check the remaining time before the receiver turns off, press SLEEP. The remaining time appears on the display. If you press SLEEP again, the sleep timer will be changed.



- 1 Press AMP.**
- 2 Press SLEEP repeatedly.**

Each time you press SLEEP, the display changes cyclically as follows:

Enjoying the surround effect at low volume levels

This function allows you to retain a theater like environment at low volume levels. This function can be used with other sound fields. When watching a movie late at night, you will be able to hear the dialog clearly even at a low volume level.

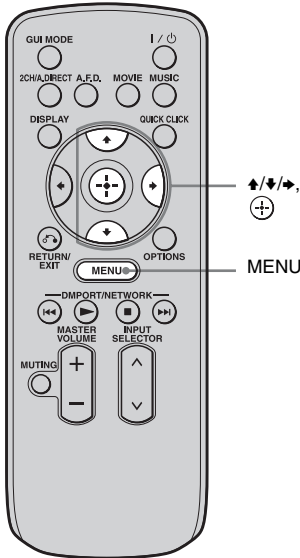

- 1 Press MENU.**
The menu is displayed on the TV screen.
- 2 Press ↑/↓ repeatedly to select “Settings,” then press ⊕ or →.**
- 3 Press ↑/↓ repeatedly to select “Audio,” then press ⊕ or →.**
- 4 Press ↑/↓ repeatedly to select “Night Mode,” then press ⊕.**

5 Press ↑/↓ repeatedly to select “On,” then press ⊕.

Notes

- This function does not work when the multi-channel input is selected.
- This function does not work when “2ch Analog Direct” is being used.
- This function does not work when Dolby TrueHD signals with a sampling frequency of 176.4 kHz and higher are being received.
- If the Night Mode function is turned on while the receiver is receiving signals with a sampling frequency of 176.4 kHz and higher, the signals will always be played back at either 44.1 kHz or 48 kHz.

Tip

While this function is on, the Bass, Treble increase, and “D. Range Comp” is automatically set to “MAX.”

Recording using the receiver

You can record from a video/audio component using the receiver. Refer to the operating instructions supplied with your recording component.

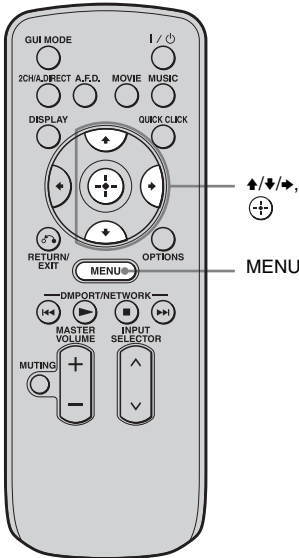

Recording onto a MiniDisc or audio tape

You can record onto a MiniDisc or audio tape using the receiver. Refer to the operating instructions supplied with your MD deck or tape deck.

- 1 Press MENU.**
- 2 Press ↑/↓ repeatedly to select “-Input,” then press ⊕ or →.**
- 3 Press ↑/↓ to select the playback component, then press ⊕.**

- 4 Prepare the playback component for playing.**

For example, insert a CD into the CD player.

- 5 Prepare the recording component.**

Insert a blank MD or tape into the recording deck and adjust the recording level.

- 6 Start recording on the recording deck, then start playback on the playback component.**

Notes

- Sound adjustments do not affect the signal output from the MD OUT jacks.
- The audio input signals from the MULTI CHANNEL INPUT jacks are not output.

To record digital sound

Connect a component for playback to the digital audio input (OPTICAL IN) jack, and connect the recording component to the OPTICAL MD OUT jack.

Recording onto recording media

- 1 Press MENU.**
- 2 Press ↑/↓ repeatedly to select “-Input,” then press ⊕ or →.**
- 3 Press ↑/↓ to select the playback component, then press ⊕.**
- 4 Prepare the component for playing.**

For example, insert the video tape you want to copy into the VCR.

5 Prepare the recording component.

Insert a blank video tape, etc., into the recording component (VIDEO 1) for recording.

6 Start recording on the recording component, then start playback on the playback component.

Notes

- Some sources contain copy guards to prevent recording. In this case, you may not be able to record from the sources.
- The audio input signals from the MULTI CHANNEL INPUT jacks are not output.
- Only analog input signals are output from the analog output jack (for recording).
- Only digital input signals are output from the digital output jack (for recording).
- HDMI sound cannot be recorded.

Switching the command mode of the receiver and the remote

You can switch the command mode (COMMAND MODE AV 1 or COMMAND MODE AV 2) of the receiver and the remote. Switch the command mode from the initial setting to the appropriate setting, if other Sony component is operated accidentally by the same remote, when you are operating the receiver using the remote supplied with the receiver.

The command modes of both the receiver and the remote are those of the initial setting (COMMAND MODE AV 2).

The receiver and the remote, on the contrary, should use the same command mode. If the command modes of the receiver and the remote are different, you cannot use the remote to operate the receiver.

Switching the command mode of the receiver

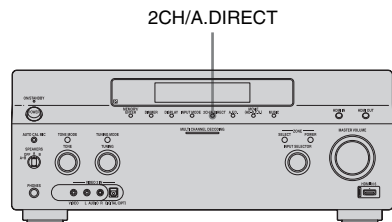



Turn on the receiver while pressing 2CH/A.DIRECT.

When the command mode is set to “AV2,” “COMMAND MODE [AV2]” appears on the display.

When the command mode is set to “AV1,” “COMMAND MODE [AV1]” appears on the display.

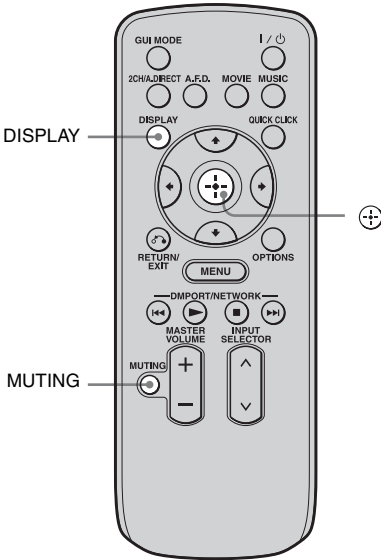
Switching the command mode of the simple remote commander



Press MUTING and  at the same time while pressing DISPLAY.

Switching the command mode of the multifunction remote commander

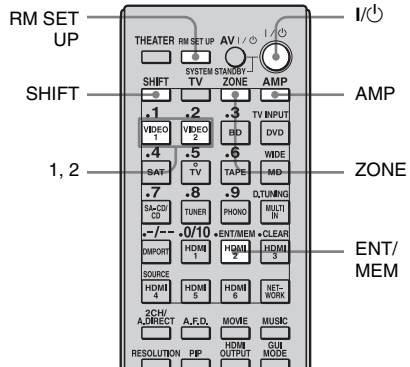

- 1** Press  while pressing RM SET UP.
The AMP and ZONE buttons flash.
- 2** Press AMP.
The ZONE button goes off, the AMP button keeps flashing and the SHIFT button lights up.
- 3** Press the numeric button 1 or 2 while the AMP button is flashing.
When you press 1, the command mode is set to AV SYSTEM 1. When you press 2, the command mode is set to AV SYSTEM 2.
The AMP button lights up.
- 4** Press ENT/MEM.
The AMP button flashes twice, then the command mode setting process is completed.

Using a bi-amplifier connection

If you are not using surround back speakers, you can use the SURROUND BACK SPEAKERS terminals for the front speakers for use with a bi-amplifier connection.

To connect speakers

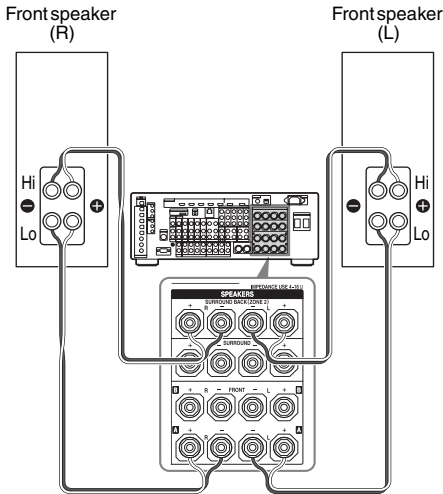

Connect the jacks on the Lo (or Hi) side of the front speakers to the FRONT SPEAKERS A terminals, and connect the jacks on the Hi (or Lo) side of the front speakers to the SURROUND BACK SPEAKERS terminals. Make sure that metal fittings of Hi/Lo attached to the speakers have been removed from the speakers. Not doing so may cause a malfunction of the receiver.

To set up speakers

- 1 Press **MENU**.
The menu is displayed on the TV screen.
- 2 Press **▲/▼** to select “**Settings**,” then press **⊕** or **▶**.

- 3 Press **▲/▼** to select “Speaker,” then press **⊕** or **▶**.
- 4 Press **▲/▼** to select “Speaker Pattern,” then press **⊕**.
- 5 Press **▲/▼** to select the appropriate speaker pattern so that there are no surround back speakers.
- 6 Press **RETURN/EXIT** **↵**.
- 7 Press **▲/▼** to select “Sur Back Assign,” then press **⊕**.
- 8 Press **▲/▼** to select “BI-AMP,” then press **⊕**.

The same signals output from the FRONT SPEAKERS A terminals can be output from the SURROUND BACK SPEAKERS terminals.

Notes

- You cannot use the FRONT SPEAKERS B terminals for a bi-amplifier connection.
- When you use the auto calibration function, make the bi-amplifier settings before you perform auto calibration.
- If you make the bi-amplifier settings, the speaker level, balance, and equalizer settings of the surround back speakers become invalid, and those of the front speakers are used.
- Signals output from the PRE OUT jacks are used with the same settings as those of the SPEAKERS terminals.
- If the Speaker Pattern is set to the setting that there are surround back speakers, you cannot make the bi-amplifier settings.

Adjusting Settings

Using the setting menu

You can adjust the various settings for speakers, surround effects, multi zone, etc. using the setting menu.

To display the menu of the receiver on the TV screen, make sure that the receiver is in “GUI MODE” by following the step in “To turn “GUI MODE” on and off” (page 60).

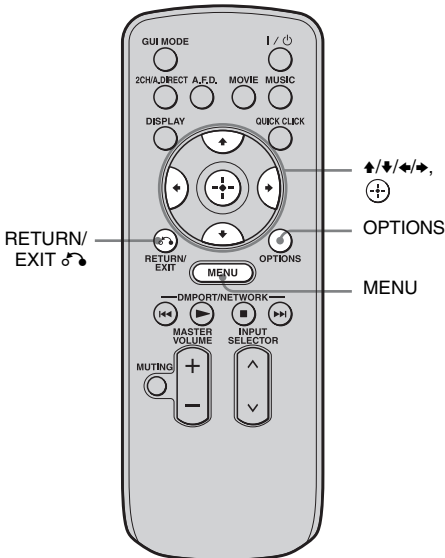

1 Press MENU.

The menu is displayed on the TV screen.

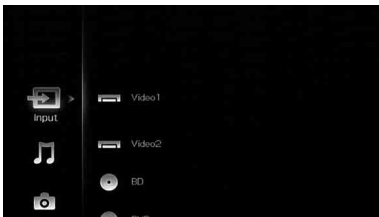

2 Press \uparrow/\downarrow repeatedly to select “Settings,” then press \oplus or \rightarrow to enter the menu mode.

The setting menu list appears on the TV screen.

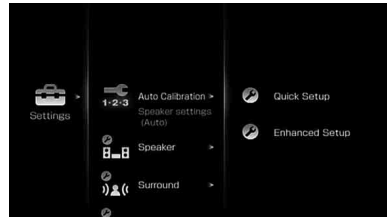

3 Press \uparrow/\downarrow repeatedly to select the menu item you want, then press \oplus to enter.

Example: When you select “Auto Calibration”

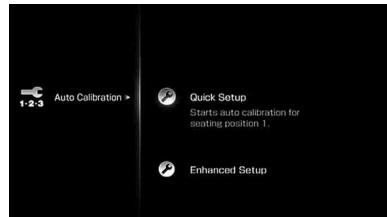

4 Press \uparrow/\downarrow repeatedly to select the parameter you want, then press \oplus to enter.

To return to the previous screen











Press RETURN/EXIT \leftarrow .

To exit the menu

Press MENU.

Setting menu list

Menu icon	Description
 Auto Calibration	Sets the speaker level or distance and makes the measurement automatically (page 128).

Menu icon	Description
 Speaker	Sets the speaker position and impedance manually (page 130).
 Surround	Adjusts the sound field (surround effect) you selected (page 134).
 EQ	Adjusts the equalizer (bass/treble sound) (page 136).
 Multi Zone	Makes the settings for Multi Zone (page 136).
 Audio	Sets various sound items (page 138).
 Video	Adjusts the resolution of analog video signals (page 140).
 HDMI	Makes settings for sound/images from components connected to the HDMI jacks (page 142).
 Network	Makes the settings for the network (page 144).
 Quick Click	Controls components connected to the receiver using the on-screen remote (page 145).
 System	Sets the screen saver or language of the menu guide display (page 146).

Auto Calibration

Quick Setup

Performs Auto Calibration. For details, see “8: Calibrating the appropriate speaker settings automatically (Auto Calibration)” (page 50).

Note

The measurement results will be overwritten and saved on Position 1 in the Enhanced Setup menu.



Enhanced Setup

You can register three patterns for “Seating Position” depending on the seating positions, listening environment, and measurement conditions.

You can also select a calibration type to compensate the each speaker.

To register more than one set of settings for the listening environment

You can select the seating position you want and register the measurement results of the auto calibration for that seating position.

- 1 Press  repeatedly on the Enhanced Setup screen to select the “Seating Position” for which you want to register the measurement results.
 - Pos. (Position) 1
 - Pos. (Position) 2
 - Pos. (Position) 3
- 2 Press  to perform auto calibration.

To set a compensation type for the speakers

You can select the compensation type to be used for the speakers for each Seating Position.

- 1 Press $\blacktriangle/\blacktriangledown$ repeatedly to select the “Seating Position” for which you want to set the speaker compensation type, then press (+) .
- 2 Press $\blacktriangle/\blacktriangledown$ repeatedly to select “Calibration Type” you want, then press (+) .
 - Full Flat
Makes the measurement of frequency from each speaker flat.
 - Engineer
Sets the frequency to match that of the Sony listening room standard.
 - Front Reference
Adjusts the characteristics of all the speakers to match the characteristics of the front speakers.
 - OFF
Sets the auto calibration EQ to off.

Note

You cannot set “Calibration Type” for “Seating Position” for which the measurement results have not been registered.

To confirm the equalizer setting for the Seating Position

- 1 Press $\blacktriangle/\blacktriangledown$ repeatedly to select the “Seating Position” for which you want to confirm the equalizer setting.
- 2 Press OPTIONS.
The option menu appears.
- 3 Press $\blacktriangle/\blacktriangledown$ repeatedly to select “EQ Curve,” then press (+) .
- 4 Press $\blacktriangleleft/\blacktriangleright$ repeatedly to select the speaker on the screen for which you want to confirm the equalizer setting.
 - FRONT
 - CENTER
 - SURROUND
 - SURROUND BACK

To name the Seating Position

- 1 Press $\blacktriangle/\blacktriangledown$ repeatedly to select the “Seating Position” for which you want to name.
- 2 Press OPTIONS.
The option menu appears.
- 3 Press $\blacktriangle/\blacktriangledown$ repeatedly to select “Name Input,” then press (+) .
The soft keyboard appears on the screen.
- 4 Press $\blacktriangle/\blacktriangledown/\blacktriangleleft/\blacktriangleright$ and (+) to select a character one by one.
- 5 Press $\blacktriangle/\blacktriangledown/\blacktriangleleft/\blacktriangleright$ to select “Finish,” then press (+) .

Speaker settings

You can adjust each speaker manually. You can also adjust the speaker levels after the auto calibration is completed.

Note

The Speaker settings are only for the current “Seating Position.”

Impedance

You can set the speaker impedance. For details, see “7: Setting the speakers” (page 48).







■ 4 Ω

■ 8 Ω

Speaker Pattern

Select “Speaker Pattern” according to the speaker system which you are using. You do not need to select the speaker pattern after auto calibration.

To select the speaker pattern

- 1 Press / repeatedly to select “Speaker Pattern,” then press .
The Speaker Pattern screen appears.
- 2 Press / to select the speaker pattern you want, then press .
- 3 Press RETURN/EXIT .

Center Mix

You can set the analog downmix settings on or off.

■ OFF

If there is a center speaker connected, this setting is set to “OFF” automatically.

■ ON

We recommend you set “Center Mix” to “ON” to enjoy digital audio with high quality sound when you do not have a center speaker connected. Analog downmix works when you set “Center Mix” to “ON.” This setting is also effective to input signals from the MULTI CHANNEL INPUT jacks.

Sur Back Assign

You can make settings for the surround back speaker(s).

■ OFF

If you have not connected surround back speakers, select “OFF.”

■ BI-AMP

If you connect front speakers in a bi-amplifier configuration, select “BI-AMP” (page 126).

■ ZONE2

If you are using the surround back speakers in zone 2, select “ZONE2.” When you select “ZONE2,” the input to the SUR BACK jacks of the MULTI CHANNEL INPUT is invalid (page 108).

Note

Set “Sur Back Assign” to “OFF,” then connect the surround back speakers to this receiver when you want to change the connection from a bi-amplifier connection or a zone 2 connection to a surround back speakers connection. Re-set up the speakers after you connect the surround back speakers. See “Auto Calibration” (page 50) or “Manual Setup” (page 131).

Manual Setup

You can adjust each speaker manually on the Manual Setup screen. You can also adjust the speaker levels after the auto calibration is completed.

To adjust the speaker level

You can adjust each speaker's level (center, surround left/right, surround back left/right, subwoofer).

- 1 Press **▲/▼/◀/▶** repeatedly to select the speaker on the screen for which you want to adjust the level, then press **⊕**.
- 2 Press **◀/▶** repeatedly to select "Level:," then press **⊕**.
- 3 Press **▲/▼** to set the level of the selected speaker, then press **⊕**.
You can adjust the level from -20 dB to +10 dB in 0.5 dB steps.
For the front left/right speakers, you can adjust the balance on either side. You can adjust the front left level from FL-10.0 dB to FL+10.0 dB in 0.5 dB steps. You can also adjust the front right level from FR-10.0 dB to FR+10.0 dB in 0.5 dB steps.

Note

When one of the sound fields for music is selected, no sound is output from the subwoofer if all the speakers are set to "LARGE." However, the sound will be output from the subwoofer if the digital input signal contains L.F.E. signals, or if the front or surround speakers are set to "SMALL," the sound field for movie is selected, or "Portable Audio" is selected.

To adjust the distance from the seating position to each speaker

You can adjust the distance from the seating position to each speaker (front left/right, center, surround left/right, surround back left/right, subwoofer.)

- 1 Press **▲/▼/◀/▶** repeatedly to select the speaker on the screen for which you want to adjust the distance from the seating position, then press **⊕**.
- 2 Press **◀/▶** repeatedly to select a "Distance:," then press **⊕**.
- 3 Press **▲/▼** to set the distance of the selected speaker, then press **⊕**.
You can adjust the distance from 1.0 meter to 10.0 meters (3 feet 3 inches to 32 feet 9 inches) in 1 cm (1 inch) steps.

To adjust the size of each speaker

You can adjust each speaker's (front left/right, center, surround left/right, surround back left/right) size.

- 1 Press **▲/▼/◀/▶** repeatedly to select the speaker on the screen for which you want to adjust the size, then press **⊕**.
- 2 Press **◀/▶** repeatedly to select a "Size:," then press **⊕**.
- 3 Press **▲/▼** to set the size of the selected speaker, then press **⊕**.
 - **LARGE**
If you connect large speakers that will effectively reproduce bass frequencies, select "LARGE." Normally, select "LARGE."
 - **SMALL**
If the sound is distorted, or you feel a lack of surround effects when using multi-channel surround sound, select "SMALL" to activate the bass redirection circuitry and output the bass frequencies of each channel from the subwoofer or other "LARGE" speakers.

Tips

- The “LARGE” and “SMALL” settings for each speaker determine whether the internal sound processor will cut the bass signal from that channel.

When the bass is cut from a channel, the bass redirection circuitry sends the corresponding bass frequencies to the subwoofer or other “LARGE” speakers.

However, since bass sound has a certain amount of directionality, it is best not to cut it, if possible.

Therefore, even when using small speakers, you can set them to “LARGE” if you want to output the bass frequencies from that speaker. On the other hand, if you are using a large speaker, but prefer not to have bass frequencies output from that speaker, set it to “SMALL.”

If the overall sound level is lower than you prefer, set all speakers to “LARGE.” If there is not enough bass, you can use the equalizer to boost the bass levels.

- The surround back speakers will be set to the same setting as that of the surround speakers.
- When the front speakers are set to “SMALL,” the center, surround, and surround back speakers are also automatically set to “SMALL.”
- If you do not use the subwoofer, the front speakers are automatically set to “LARGE.”

Crossover Freq (Speaker crossover frequency)

Lets you set the bass crossover frequency of speakers that has been set to “SMALL” in the Speaker menu. Measured speaker crossover frequency is set for each speaker after the auto calibration.

- 1 Press \leftarrow/\rightarrow to select the speaker on the screen you want to adjust.**
- 2 Press \uparrow/\downarrow to adjust the value, then press \rightarrow or RETURN/EXIT .**

Test Tone



You can select the test tone type on the Test Tone screen.

Tips

- To adjust the level of all speakers at the same time, press MASTER VOLUME +/-.
- The adjusted value is shown on the display during adjustment.



To output a test tone from each speaker

You can output a test tone from the speakers in sequence.

- 1 Press \leftarrow/\rightarrow to select “Test Tone,” then press .**
The Test Tone screen appears.
- 2 Press \uparrow/\downarrow to adjust the parameter, then press .**
 - OFF
 - AUTO
The test tone is output from each speaker in sequence.
 - L, C, R, SR, SBR, SBL, SL, SW
You can select which speakers will output the test tone.
- 3 Press \uparrow/\downarrow to adjust “Level:,” then press .**

To output a test tone from adjacent speakers

You can output a test tone from adjacent speakers so that you can adjust the balance between the speakers.

- 1 Press \leftarrow/\rightarrow to select “Phase Noise,” then press .**
The Phase Noise screen appears.
- 2 Press \uparrow/\downarrow to adjust the parameter, then press .**
 - OFF
 - L/R, L/C, C/R, R/SL, R/SR, SR/SL, SR/SBR, SBR/SBL, SR/SB, SBL/SL, SB/SL, SL/L, L/SR
Lets you output the test tone sequentially

from adjacent speakers.
Some items may not be displayed,
depending on the setting of the speaker
pattern.

- 3 Press \uparrow/\downarrow to adjust “Level;,” then press \oplus .

To output the source sound from adjacent speakers

You can output the source sound from adjacent speakers so that you can adjust the balance between the speakers.

- 1 Press \leftarrow/\rightarrow to select “Phase Audio,” then press \oplus .
The Phase Audio screen appears.

- 2 Press \uparrow/\downarrow to adjust the parameter, then press \oplus .

- OFF
- L/R, L/C, C/R, R/SL, R/SR, SR/SL, SR/SBR, SBR/SBL, SR/SB, SBL/SL, SB/SL, SL/L, L/SR

Lets you output front 2 channel source sound (instead of the test tone) sequentially from adjacent speakers.
Some items may not be displayed, depending on the setting of the speaker pattern.

- 3 Press \uparrow/\downarrow to adjust “Level;,” then press \oplus .

When a test tone is not output from the speakers

- The speaker cords may not be connected securely. Check to see if they are connected securely and cannot be disconnected by pulling on them slightly.
- The speaker cords may have the short-circuit problem.

When a test tone is output from a different speaker than the speaker displayed on the screen

The speaker pattern to the connected speaker is not set up correctly. Make sure the speaker connection and the speaker pattern match.

D. Range Comp (Dynamic range compressor)

Lets you compress the dynamic range of the soundtrack. This may be useful when you want to watch movies at low volumes late at night. Dynamic range compression is possible with Dolby Digital sources only.

■ OFF

The dynamic range is not compressed.

■ AUTO

The dynamic range is compressed automatically.

■ STD

The dynamic range is compressed as intended by the recording engineer.

■ MAX

The dynamic range is compressed dramatically.

Tips

- Dynamic range compressor lets you compress the dynamic range of the soundtrack based on the dynamic range information included in the Dolby Digital signal.
- “STD” is the standard setting, but it only enacts light compression. Therefore, we recommend using the “MAX” setting. This greatly compresses the dynamic range and lets you view movies late at night at low volumes. Unlike analog limiters, the levels are predetermined and provide a very natural compression.

Distance Unit (Distance unit)

Lets you select the unit of measure for setting distances.

■ meter

The distance is displayed in meters.

■ feet

The distance is displayed in feet.

Surround settings

You can adjust the sound effect on the Sound Field Setup screen.

Note

The setup items you can adjust on each menu vary depending on the sound field.

Sound Field Setup

You can select the surround sound field and adjust the effect level on the Sound Field Setup screen.

For details on the sound field, see “Enjoying Surround Sound” (page 82).

To select the surround sound field

- 1 Press **▲/▼** repeatedly to select “Sound Field Setup,” then press **⊕**.
- 2 Press **▲/▼** repeatedly to select the surround sound you want.
- 3 Press RETURN/EXIT **↵**.

To select the Effect Type for HD-D.C.S.

- 1 Press **▲/▼** repeatedly to select “Sound Field Setup,” then press **⊕**.
- 2 Press **▲/▼** repeatedly to select “HD-D.C.S.,” then press **▶**.
- 3 Press **▲/▼** to select the Effect Type you want, then press **◀**.
HD-D.C.S. has three different types: Theater, Dynamic, and Studio. Each type has different reflection and reverberation sound mixture levels and is optimized to match a listener’s room uniqueness, taste and mood.

- **Theater**
Theater type (default setting) mixes reflection and reverberation sound creating the characteristics of a mastering studio. Additionally, this type mixes in frequency characteristics that are often found in professional studios and movie theaters. It is ideal for watching movies in a listening room that has less reverberation.
- **Dynamic**
Want to enjoy the sound effects to the full extent, just like at the movie theaters? Dynamic type emphasizes on the reflection sound. Without HD-D.C.S., many rooms are often somewhat reverberant but lack a spacious feeling. This type acoustically opens up those types of rooms and provides a spacious and dynamism feeling equivalent to a mastering studio.
- **Studio**
In Studio type, effects are kept to a minimum, while still providing a great theater experience. This type provides the accuracy of the original recording.

4 Press RETURN/EXIT .

Enhanced Sur Mode

You can select the decoding mode for the sound field.

For details on the decoding modes available, see “Setting a multi-channel surround sound effect” (page 84).

■ Pro Logic II

Performs Dolby Pro Logic II decoding. A source recorded in 2 channel format is decoded into 5.1 channels.

■ Pro Logic IIX

Performs Dolby Pro Logic IIX decoding. A source recorded in 2 channel or 5.1 channel format is decoded into 7.1 channels.

■ Neo:6 Cinema

Performs DTS Neo:6 Cinema mode decoding. A source recorded in 2 channel format is decoded into 7 channels.

■ Neo:6 Music

Performs DTS Neo:6 Music mode decoding. A source recorded in 2 channel format is decoded into 7 channels. This setting is ideal for normal stereo sources such as CDs.

■ Neural-THX

Next generation of Neural-THX[®] Surround. In addition to stereo enhancement processing and pure discrete 5.1 surround sound, now capable of full 360° 7.1 surround sound playback from Neural-THX[®] surround encoded content.

Note

You can select “Pro Logic II” when there is no surround back speaker on the Speaker Pattern menu, or you can select “Pro Logic IIX” when there is a surround back speaker. You cannot select both settings at the same time.

EQ settings

You can use following parameters to adjust the tonal quality (bass/treble level) of front, center and surround/surround back speakers.

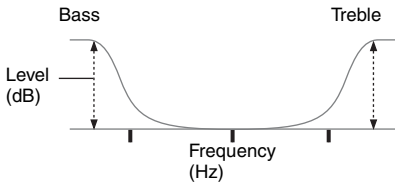

Notes

- This function does not work in the following cases.
 - The multi-channel input is selected.
 - “2ch Analog Direct” is being used.
 - Dolby TrueHD signals with a sampling frequency of 176.4 kHz and higher are being received.
- If the equalizer is adjusted while the receiver is receiving signals with a sampling frequency of 176.4 kHz and higher, the signals will always be played back at either 44.1 kHz or 48 kHz.

To adjust the equalizer on the EQ screen

- 1 Press \leftarrow/\rightarrow to select the speaker on the screen you want to adjust, then press \odot .
- 2 Press \leftarrow/\rightarrow to select “Bass” or “Treble.”
- 3 Press \uparrow/\downarrow to adjust the gain, then press \odot .

Multi Zone settings

You can make settings for the main zone, zone 2 or zone 3.

Multi Zone Setup

To turn the power on or off for zone 2/zone 3

You can turn zone 2 or zone 3 operation on or off. “Main” (this receiver) is always selected. You cannot turn it off.

- 1 Press \uparrow/\downarrow to select the zone you want to turn on or off, then press \odot .
- 2 Press \uparrow/\downarrow to select “ON” or “OFF,” then press \odot .

■ ON

■ OFF

To select the output source for each zone

You can select the source that is output to the zone. Audio and video signals are output to zone 2, while only audio signals are output to zone 3.

- 1 Press \uparrow/\downarrow to select the zone to which you want to output audio/video signals, then press \odot .
- 2 Press \leftarrow/\rightarrow to select “Input,” then press \odot .
- 3 Press \uparrow/\downarrow to select the input, then press \odot .

To adjust the volume for zone 2

You can adjust the volume in the main zone. If “Sur Back Assign” is set to “ZONE2” in the Speaker settings menu, you can also adjust the volume of zone 2.

- 1 Press **▲/▼** to select the zone for which you want to adjust the volume, then press **⊕**.
- 2 Press **←/→** to select “Volume,” then press **⊕**.
- 3 Press **▲/▼** to adjust the volume, then press **⊕**.

To select the criteria for output of signals to control each zone

You can turn the receiver on or off in another zone, or select various options for use of the 12V Trigger function.

- 1 Press **▲/▼** to select the zone you want, then press **⊕**.
- 2 Press **←/→** to select “12V Trigger.”
- 3 Press **▲/▼** to select the parameter, then press **⊕**.

■ OFF

Lets you turn off output of 12V triggers even when the main receiver is turned on.

■ CTRL

Lets you turn the output of 12V triggers on or off manually using the CIS command of the external control device.

■ ZONE

Lets you turn the output of 12V triggers on or off based on whether the selected zone is turned on or off.

■ INPUT (for “Main” only)

Lets you turn on the output of 12V triggers when the preset input is selected.

When you select “Input,” the setting display which sets each input trigger to on/off appears. Press **▲/▼** to select the input, then press **⊕** to check the box.

■ HDMI A (for “Main” only)

Lets you turn the output of 12V triggers on or off based on the output setting of the HDMI OUT A jack.

■ HDMI B (for “Main” only)

Lets you turn the output of 12V triggers on or off based on the output setting of the HDMI OUT B jack.

■ MAIN (for “Zone2” and “Zone3” only)

Lets you link operation of trigger in zone 2 or zone 3 to the main receiver.

Tips

- Even when this receiver is standby mode (press **I/⏻** on the remote to turned off this receiver), the receiver in zone 2 or zone 3 remains turned on. To turn off all receivers, press **I/⏻** and **AV I/⏻** on the multifunction remote at the same time (SYSTEM STANDBY).
- Only signals from components connected to the analog input jacks are output through the ZONE 2 OUT/ZONE 3 OUT jacks. No signals are output from components connected to only the digital input jacks.
- When SOURCE is selected, the signals input to the MULTI CHANNEL INPUT jacks are not output from the ZONE 2 OUT or ZONE 3 OUT jacks even when the multi-channel input is selected. The analog audio signals of the current function are output.
- When “Tuner” is selected; the same type of radio station (FM/AM) selected in the main zone is set in zone 2 and zone 3. However, you can select the input other than “Tuner” in zone 2 and zone 3.
- When the receiver in the main zone is turned off, or an input source other than “Tuner” is selected, you can select a radio station from AM or FM in zone 2 or zone 3.
When two of the receivers in the main zone, zone 2 or zone 3 are turned off and an input source other than “Tuner” is selected, you can select a broadcast from FM/AM in one zone in which the receiver is turned on.

Party Setup

Lets you select the zone which plays back the same music as the main zone when you press the PARTY button to start the party mode.

■ ZONE2+ZONE3

■ ZONE2

■ ZONE3

Audio settings

You can make settings for the audio to suit your preference.

Digital Legato Linear (D.L.L.)

When you set this setting to “AUTO,” the receiver plays back the sound recorded using lossy compression with high quality sound. If the CD sound is recorded using Linear PCM, the CD sound quality level will be increased further.

■ OFF

■ AUTO

Note

D.L.L. is available for LPCM 44.1 kHz, Dolby Digital, DTS, or analog signals.

A/V Sync (Synchronizes audio and video output)

Lets you delay the output of audio to minimize the time gap between audio output and visual display.

■ HDMI AUTO

The time gap between audio output and visual display for the monitor connected via an HDMI connection will be adjusted automatically based on the information for the TV. This feature is available only when the monitor supports the A/V Sync function.

■ 0 ms – 300 ms

You can adjust the delay from 0 ms to 300 ms in 10 ms steps.

Notes

- This function is useful when you use a large LCD or plasma monitor or a projector.
- This function does not work in the following cases.
 - The multi-channel input is selected.
 - “2ch Analog Direct” is being used.

Dual Mono (Digital broadcast language selection)

Lets you select the language you want when you listen to the dual audio of a digital broadcast. This feature only functions for Dolby Digital sources.

■ MAIN/SUB

Sound of the main language will be output through the front left speaker, and sound of the sub language will be output through the front right speaker simultaneously.

■ MAIN

Sound of the main language will be output.

■ SUB

Sound of the sub language will be output.

Decode Priority (Digital audio input decoding priority)

Lets you specify the input mode for the digital signal input to the DIGITAL IN jacks or HDMI IN jacks.

■ PCM

When signals from the DIGITAL IN jack are selected, PCM signals are given priority (to prevent interruption when playback starts). However, when other signals are input, there may be no sound, depending on the format. In this case, set this item to "AUTO."

When signals from the HDMI IN jack are selected, only PCM signals are output from the connected player. When signals in any other format are received, set this item to "AUTO."

■ AUTO

Automatically switches the input mode between Dolby Digital, DTS, or PCM.

Note

Even when "Decode Priority" is set to "PCM," the sound may be interrupted at the very beginning of the first track due to signals on the CD being played back.

Night Mode

Lets you to retain a theater-like environment at low volume levels. This function can be used with other sound fields. When watching a movie late at night, you will be able to hear the dialog clearly even at a low volume level.

■ ON

■ OFF

Video settings

Makes settings for video.

Resolution (Converting video signals)

Lets you convert the resolution of analog video input signals.

For details on video input/output conversion classified according to the Resolution menu settings, see Figure 1 on page 141.

■ **AUTO**

■ **DIRECT**

Lets you output analog video input signals without conversion.

■ **480i/576i**

■ **480p/576p**

■ **720p**

■ **1080i**

■ **1080p**

Figure 1

“Resolution” menu setting	Output from	HDMI OUT jacks	MONITOR COMPONENT VIDEO OUT jacks	MONITOR VIDEO OUT jack
	Input signals			
DIRECT	Component video	–	○	–
	Composite video	–	–	○
AUTO (initial setting)	Component video	● ^{a)}	● ^{b)}	● ^{b)}
	Composite video	–	● ^{b)}	● ^{b)}
480i/576i	Component video	● ^{c)}	●	●
	Composite video	● ^{c)}	●	●
480p/576p	Component video	●	●	–
	Composite video	●	●	○
720p, 1080i	Component video	●	● ^{d)}	–
	Composite video	●	● ^{d)}	○
1080p	Component video	●	○	–
	Composite video	●	–	○

● : Video signals are converted and output through the video converter.

○ : The same type of signal as that of the input signal is output. Video signals are not converted.

– : Video signals are not output.

a)The resolution is set automatically, depending on the connected monitor.

b)When the TV is connected to jacks other than the HDMI jacks, 480i/576i signals are output when “Resolution” is set to “AUTO.”

c)480p/576p signals are output even if 480i/576i is set.

d)Video signals without copyright protection are output based on the settings menu. Video signals with copyright protection are output as 480p.

Notes

- Video signals are not output from the COMPONENT VIDEO MONITOR OUT or MONITOR VIDEO OUT jacks when the monitor, etc., is connected to HDMI OUT jacks.
- If you select a resolution that the connected TV does not support in the “Resolution” menu, the images from the TV cannot be output correctly.
- Converted HDMI image output signals do not support “x.v.Color.”
- Converted HDMI image output signals do not support Deep Color.

HDMI settings

Makes the required settings for components connected to the HDMI jacks.

Control for HDMI

Lets you turn the function which controls components connected to the HDMI jack using an HDMI cable on or off.

■ OFF

■ ON

Note

When you set “Control for HDMI” to “ON,” “Audio Out” may be changed automatically.

For European model

When “Control for HDMI” is turned on and off, the H.A.T.S. (High quality digital Audio Transmission System) function turns on and off in conjunction with the “Control for HDMI” function. When the H.A.T.S. function is on, the sound quality is enhanced because there is no jitter (timing gaps when reading signals) when transmitting digital audio signals.

Notes

- It takes some time to output the sound after a playback operation is performed on the connected component (e.g., pressing the PLAY button, pressing the STOP button, pressing the PAUSE button) due to limitations of the H.A.T.S. system. The time lag depends on the sound source. This feature may be ineffective depending on the component and the sound source, even if you set it to ON.
- The components connected to the HDMI jack must support the H.A.T.S. feature.
- When “Audio Out” is set to “TV+AMP,” the H.A.T.S. function may not work depending on the component connected or the status of that component. In this case, select “AMP” for “Audio Out.”

- The H.A.T.S. function of this receiver works when a Sony SCD-XA5400ES is connected to the receiver.

Stream information about the H.A.T.S. function available

Audio signal input	Sampling frequency
Linear PCM 2ch	44.1 kHz, 48 kHz, 88.2 kHz, 96 kHz, 176.4 kHz, 192 kHz
Linear PCM Multi	44.1 kHz, 48 kHz, 88.2 kHz, 96 kHz, 176.4 kHz, 192 kHz
DSD	2.8224 MHz

Pass Through

Lets you output the HDMI signals to the TV even when the receiver is in standby mode. For details, see “Outputting the HDMI signals even when the receiver is in standby mode (Pass Through)” (page 116).

■ OFF

■ AUTO

■ ON

Note

When “Control for HDMI” is set to “OFF,” you cannot set “Pass Through.”

Audio Out (Setting HDMI audio input)

Lets you set the HDMI audio signals output from the playback component connected to the receiver via an HDMI connection.

■ TV+AMP

The sound is output from the TV speaker and the speakers connected to the receiver.

Notes

- The sound quality of the playback component depends on the TV's sound quality, such as the number of channels, and the sampling frequency, etc. When the TV has stereo speakers, the sound output from the receiver is also stereo as that of the TV, even if you play multi-channel source.
- When you connect the receiver to a video component (projector, etc.), sound may not be output from the receiver. In this case, select "AMP."
- When you select the input that you have assigned the HDMI input, sound does not output from the TV.

■ AMP

The HDMI audio signals from the playback component is only output to speakers connected to the receiver. The multi-channel sound can be played back as it is.

Note

Audio signals are not output from the the TV speaker when "Audio Out" is set to "AMP."

24p Auto Sound Sync

Lets you turn the "24p Auto Sound Sync" function on or off. This allows HD-D.C.S. to be selected as the optimum sound field automatically when 24p (24 frames per second) signals are input from a playback component, such as a Blu-ray Disc Player.

■ ON

■ OFF

Note

When "Control for HDMI" is set to "ON," depending on the player, the sound field may not switch to HD-D.C.S.

When "Control for HDMI" is set to "ON," the receiver detects the 24p signals via "BRAVIA" Sync. Therefore, if a player that is not compatible with "BRAVIA" Sync sends out 24p signals, the receiver will not switch the sound field to HD-D.C.S. In this case, set "Control for HDMI" to "OFF." When "Control for HDMI" is set to "OFF," the receiver detects the 24p signals by itself.

Subwoofer Level

Lets you set the level of the subwoofer to 0 dB or +10 dB when PCM signals are input via an HDMI connection. You can set the level for each HDMI input independently.

■ 0 dB

■ AUTO

Automatically sets the level to 0 dB or +10 dB depending on the frequency.

■ +10 dB

Video Direct

Lets you output the video input signals from the HDMI IN jack directly to the HDMI OUT jack.

■ OFF

The input signals from the HDMI IN jack are output through a video processor.

■ ON

The input signals from the HDMI IN jack are output directly.

Network settings

Makes the settings for the network.

Network Setup

Lets you make the network settings.

To check the network settings

- 1 Press **▲/▼** repeatedly to select “Network Setup,” then press **⊕**.
- 2 Press **▲/▼** repeatedly to select “Network Information,” then press **⊕**.
The network setting information of the receiver is displayed on the TV screen.

To configure network settings automatically

- 1 Press **▲/▼** repeatedly to select “Network Setup,” then press **⊕**.
- 2 Press **▲/▼** repeatedly to select “Internet Setup,” then press **⊕**.
- 3 Press **▲/▼** repeatedly to select “Connect Automatically (DHCP),” then press **⊕**.
“Success! The receiver is now connected to network.” appears on the TV screen.
- 4 Press **⊕** to select “Finish.”

To set the IP address manually

- 1 Press **▲/▼** repeatedly to select “Network Setup,” then press **⊕**.
- 2 Press **▲/▼** repeatedly to select “Internet Setup,” then press **⊕**.
- 3 Press **▲/▼** repeatedly to select “Manual Configuration,” then press **⊕**.
The setting screen for the IP address appears on the TV screen.
- 4 Press **⊕** to select the IP address.

The soft keyboard appears on the TV screen.

- 5 Press **▲/▼/◀/▶** and **⊕** to select a character one by one to enter the IP address.
- 6 Press **▲/▼/◀/▶** to select “Finish,” then press **⊕**.
- 7 Press **▶** to display the next screen.
- 8 Repeat the process in steps 4 to 7 again to enter the Subnet Mask, Gateway address, DNS1 address, and DNS2 address.
- 9 Press **▲/▼** to select “Test Connection,” then press **⊕**.
“Success! The receiver is now connected to network.” appears on the TV screen.
- 10 Press **⊕** to select “Finish.”

To set the Proxy server manually

- 1 Press **▲/▼** repeatedly to select “Network Setup,” then press **⊕**.
- 2 Press **▲/▼** repeatedly to select “Proxy Setup,” then press **⊕**.
- 3 Press **▲/▼** repeatedly to select “Enable,” then press **⊕**.
- 4 Press **⊕**.
The soft keyboard appears on the TV screen.
- 5 Press **▲/▼/◀/▶** and **⊕** to select a character one by one to enter the proxy server address.
- 6 Press **▲/▼/◀/▶** repeatedly to select “Finish,” then press **⊕**.
- 7 Press **▶** to select the Port number box, then press **⊕**.
The soft keyboard appears on the TV screen.

- 8 Press $\blacktriangle/\blacktriangledown/\blacktriangleleft/\blacktriangleright$ and \oplus to select a character one by one to enter the port number.
- 9 Press $\blacktriangle/\blacktriangledown/\blacktriangleleft/\blacktriangleright$ repeatedly to select “Finish,” then press \oplus .
- 10 Press \blacktriangleright .
- 11 Press $\blacktriangle/\blacktriangledown$ repeatedly to select “Finish,” then press \oplus .

Rhapsody Account

Lets you enter the Rhapsody Account number to listen to the Rhapsody Internet radio service. For details, see “Setting an account” (page 98). Rhapsody is only available in the US.

Quick Click settings

Controls components connected to the receiver using the on-screen remote.

Source Component

Selects the source component that is to be operated.

■ Preset Mode

Customizes the remote to match the source components connected to your receiver.

■ Learn Mode

Allows the remote learn codes.

■ Reset

Resets both programmed codes and learned codes.

Common Component

Selects the common component such as a TV, projector or lights that is to be operated.

■ Preset Mode

Customizes the remote to match the common components such as the TV, the projector and the lightings connected to your receiver.

■ Learn Mode

Allows the remote to learn codes.

■ Reset

Resets both programmed codes and learned codes.

Macro Setup

Sets several commands in a sequential order as a single command.

System settings

Customizes the settings of the receiver.

Screen Saver

Lets you activate the screen saver function for the GUI menu on the TV connected to the receiver.

■ OFF

The screen saver function is disabled.

■ ON

When there has been no operation attempted for 15 minutes, the screen saver function is activated automatically.

Installer Mode

Selects the control mode for maintenance and service.

■ OFF

■ RS232C

■ Network

Language

Selects the language for the messages on the screen.

■ English

■ Español

■ Français

■ Deutsch

System Update

You can check the version of the firmware on the system of the receiver, and you can also update the firmware of the receiver.

You can also update the firmware of the receiver using the ES Utility application software provided on the CD-ROM supplied with the receiver. For details, see “Updating the receiver firmware using the ES Utility” (page 103).

To check the system information

- 1 Press **▲/▼** repeatedly to select “System Update,” then press **⊕**.
- 2 Press **▲/▼** repeatedly to select “Internet Update,” then press **⊕**.
The system information of the receiver appears on the TV screen.
- 3 Press **←/→** to select “Cancel,” then press **⊕**.

To update the receiver using the menu

- 1 Press **▲/▼** repeatedly to select “System Update,” then press **⊕**.
- 2 Press **▲/▼** repeatedly to select “Internet Update,” then press **⊕**.
The current system version and latest system version are displayed on the TV screen.
- 3 Press **⊕** to select “Update.”
A confirmation screen appears on the TV screen.
- 4 Press **▲/▼** repeatedly to select “Start,” then press **⊕**.
Receiver updating starts.
The MULTI CHANNEL DECODING lamp on the front panel flashes while updating.
When the updating complete, the receiver will restart automatically.

Notes

- In the following cases, a message appears on the TV screen and the update of the receiver is not performed.
 - when all versions are the latest one.
 - when the receiver cannot retrieve the data, such as when the network has not been set up, or when the server is down, etc.
- Do not turn the receiver off or disconnect the network cable during firmware updating. It may cause a malfunction.
- It may take 30 minutes for the firmware updating to complete.

Operating without connecting to a TV

You can operate the receiver using the display window of the receiver even if the TV is not connected to the receiver.

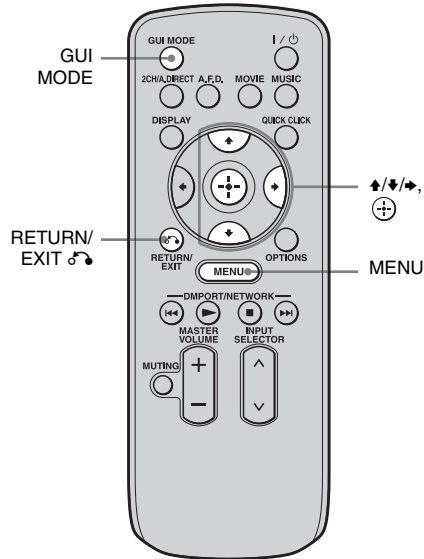

Using the menu in the display window

If “GUI MODE” is displayed in the display window of the receiver when you press MENU, DISPLAY, or \uparrow/\downarrow , press GUI MODE to switch the display mode of the menu to “DISPLAY MODE.” (After “GUI MODE OFF” has appeared in the display window of the receiver, the receiver is switched to “DISPLAY MODE.”)

- 1 Turn on the receiver.**

2 Press MENU.

The menu is displayed in the display window of the receiver.

Example: When you select "Speaker Settings"



3 Press ▲/▼ repeatedly to select the menu, then press (+/-) or →.

4 Press ▲/▼ repeatedly to select the menu item, then press (+/-).

The parameter appears in brackets.



5 Press ▲/▼ repeatedly to select the parameter you want, then press (+/-).

The parameter is entered and the brackets disappear from the display.



Tip

To return to the previous step, press RETURN/EXIT .

Menu list (in the display window)

The following options are available in each menu.

“■ ■...” in the table signifies the parameter for each item.

Menu	Item	Parameter	Initial setting	
Auto Calibration	AUTO CAL START?			
		5 4 3 2 1		
		MEASURING: TONE		
		MEASURING: T.S.P.		
		MEASURING: WOOFER		
		COMPLETE [■■■■■■■■■■]	RETRY, SAVE EXIT, WRN CHECK, PHASE INFO, DIST. INFO, LEVEL INFO, EXIT	SAVE EXIT
		WARNING CODE [■■■■:4■]	FL, FR, C, SLA, SRA, SLB, SRB, SBL, SBR : 0, 1, 2, 3, 4	
		NO WARNING		
		ERROR CODE [■■■:3■]	F, SR, SB : 0, 1, 2, 3, 4	
		RETRY? [■■■■]	YES, EXIT	YES
		CANCEL		
		CAL TYPE [■■■■■■■■■■]	ENGINEER, FULL FLAT, FRONT REF, OFF	FULL FLAT
		POSITION [■■■■■■■■■■]	POS.1, POS.2, POS.3	POS.1
		NAME IN ? [■■■■■■■■■■]		
	Level Settings	TEST TONE [■■■■■■■■■■]	OFF, L to SW (AUTO), L to SW (FIX)	OFF
PHASE NOISE [■■■■■■■■■■]		OFF, L/C, C/R, R/SL, R/SR, SR/SL, SR/SBR, SBR/SBL, SBL/SL, SL/L, L/SR	OFF	
PHASE AUDIO [■■■■■■■■■■]		OFF, L/C, C/R, R/SL, R/SR, SR/SL, SR/SBR, SBR/SBL, SBL/SL, SL/L, L/SR	OFF	
FRONT L [■■■■.■dB]		-10.0dB to +10.0dB (0.5dB step)	0dB	
FRONT R [■■■■.■dB]		-10.0dB to +10.0dB (0.5dB step)	0dB	
CENTER [■■■■.■dB]		-20.0dB to +10.0dB (0.5dB step)	0dB	
SURROUND L [■■■■.■dB]		-20.0dB to +10.0dB (0.5dB step)	0dB	
SURROUND R [■■■■.■dB]		-20.0dB to +10.0dB (0.5dB step)	0dB	
SUR BACK [■■■■.■dB]		-20.0dB to +10.0dB (0.5dB step)	0dB	
SUR BACK L [■■■■.■dB]		-20.0dB to +10.0dB (0.5dB step)	0dB	
SUR BACK R [■■■■.■dB]		-20.0dB to +10.0dB (0.5dB step)	0dB	
SUB WOOFER [■■■■.■dB]		-20.0dB to +10.0dB (0.5dB step)	0dB	
D. RANGE COMP. [■■■■]		OFF, AUTO, STD, MAX	AUTO	

Menu	Item	Parameter	Initial setting
Speaker Settings	SP PATTERN [■■■■■■■]	2/0 to 3/4.1 (16 patterns)	3/4.1
	FRONT SIZE [■■■■■■■]	SMALL, LARGE	LARGE
	CENTER SIZE [■■■■■■■]	SMALL, LARGE	LARGE
	SURROUND SIZE [■■■■■■■]	SMALL, LARGE	LARGE
	SB ASSIGN [■■■■■■■]	OFF, BI-AMP, ZONE2	OFF
	FRONT L [■■■■■■■■■■■]		
	FRONT R [■■■■■■■■■■■]		
	CENTER [■■■■■■■■■■■]		
	SURROUND L [■■■■■■■■■■■]		
	SURROUND R [■■■■■■■■■■■]	3' 3" to 32' 9" (1 inch step)	9' 10"
	SUR BACK [■■■■■■■■■■■]	1.0 to 10.0 (m) (0.1 m step)	3m
	SUR BACK L [■■■■■■■■■■■]		
	SUR BACK R [■■■■■■■■■■■]		
	SUB WOOFER [■■■■■■■■■■■]		
	DISTANCE UNIT [■■■■■■■]	meter, feet	feet*
	FR CROSSOVER** [■■■■■■■]	40 to 200 (10 Hz step)	120
	CNT CROSSOVER** [■■■■■■■]	40 to 200 (10 Hz step)	120
	SUR CROSSOVER** [■■■■■■■]	40 to 200 (10 Hz step)	120
	CNT A.DOWN MIX [■■■■■]	OFF, ON	OFF
	SP IMPEDANCE [■ohm]	4ohm, 8ohm	8ohm

* meter for European model

** You cannot select this setting when the speaker is set to "LARGE."

Menu	Item	Parameter	Initial setting
HDMI Settings	CTRL FOR HDMI [■■■■]	OFF, ON	OFF
	PASS THROUGH [■■■■■]	OFF, AUTO, ON	OFF
	AUDIO OUT [■■■■■■■]	TV+AMP, AMP	AMP
	24p SOUND SYNC [■■■■]	OFF, ON	ON
	SW LEVEL [■■■■dB]	AUTO, +10dB, 0dB	AUTO
	VIDEO DIRECT [■■■■]	OFF, ON	OFF
System Settings	NAME IN ? [■■■■■■■■■]		
	PARTY SETUP [■■■■■■■■■]	ZONE2/3, ZONE2, ZONE3	ZONE2/3
	12V TRIG. MAIN [■■■■■■■]	OFF, CTRL, ZONE, INPUT, HDMI A, HDMI B	OFF
	12V TRIG. ZONE2 [■■■■■■■]	OFF, CTRL, ZONE, MAIN	OFF
	12V TRIG. ZONE3 [■■■■■■■]	OFF, CTRL, ZONE, MAIN	OFF
	INSTALLER MODE [■■■■■■■]	OFF, 232C, NET	OFF
	VERSION [■.■■■■]	-	-

To change the display

You can check the sound field, etc., by changing the information on the display.

- 1 Select the input for which you want to check the information.
- 2 Press DISPLAY repeatedly.
Each time you press DISPLAY, the display will change as follows.
Input you selected → Sound field type → Input name you entered ...

When listening to FM and AM radio
Station name → Frequency → Sound field type...

Index name appears only when you have assigned one to the input or preset station.
Index name does not appear when only blank spaces have been entered.

When tuning in a channel from a satellite tuner (USA/Canadian model only)
Channel name → Channel number → Category → Artist name → Song title → Composer name (SIRIUS only) → Signal strength → Sound field type

When receiving RDS broadcasts (European model only)

PS (Program Service name)^{a)}, Preset name, Band, or Preset number → Frequency, band and preset number → PTY (Program Type) indication^{b)} → RT (Radio Text) indication^{c)} → Sound field type

a) This information also appears for non-RDS FM stations.

b) Type of program being broadcast

c) Text messages sent by the RDS station.

Operating components or lighting connected to the receiver using the on-screen remote (Quick Click)

You can control components connected to the receiver, a projector, and the light control unit using the on-screen remote on the TV screen.

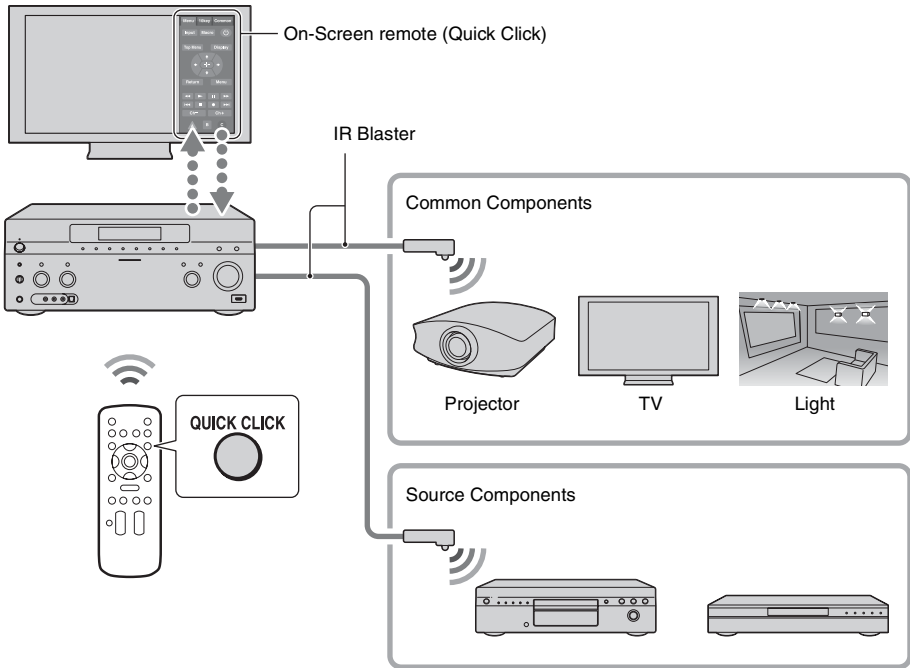

Using Quick Click

You can control components connected to the receiver, a TV, projector, or lighting using the on-screen remote on the TV screen.

Note

You may not be able to operate some functions for the components you are using.

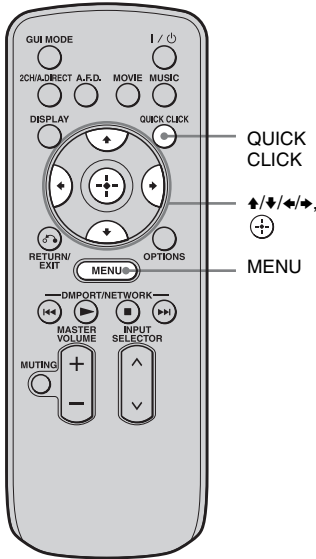

- 1 Press MENU.**
The menu is displayed on the TV screen.
- 2 Press ↑/↓ repeatedly to select “Input,” then press ⊕ or →.**
- 3 Press ↑/↓ repeatedly to select the component you want, then press ⊕.**
- 4 Press QUICK CLICK.**
- 5 Press ↑/↓/←/→ repeatedly to select the appropriated buttons on the on-screen remote to use the function listed in the table below, then press ⊕.**

Table of buttons used to control each component (Quick Click)

See “Operating the components connected to the receiver” for details on the buttons of the on-screen remote.

Category	TV	VCR	PROJECTOR	BD/DVD	LD	CD	MD	CABLE	SAT	TAPE	DVR	LIGHT
Button												
⏻	●	●	●	●	●	●	●	●	●	●	●	●
10 key	●	●	–	●	●	●	●	●	●	●	●	–
+10 (●)	●	–	–	●	●	●	●	●	●	–	●	–
Ent	●	●	–	●	●	●	●	●	●	●	●	–
Input	●	●	●	●	–	–	–	●	●	–	●	–
Display (Info)	●	●	●	●	●	●	●	●	●	●	●	–
Top Menu (Guide)	●	–	–	●	–	–	–	●	●	–	●	–
◀◀/▶▶/▶▶/■/	–	●	–	●	●	●	●	●	●	●	●	–
●	–	●	–	●	–	–	●	●	●	●	●	–
◀◀/▶▶	–	–	–	●	●	●	●	●	●	●	●	–
↕/↔/↔/Menu/ Ⓢ/Exit/Return	●	●	●	●	–	–	–	●	●	–	●	–
Ch +/-	●	●	–	–	–	–	–	●	●	–	●	–
A/B/C	–	–	–	–	–	–	–	●	–	–	–	–
Scene 1-16	–	–	–	–	–	–	–	–	–	–	–	●
All On/Off	–	–	–	–	–	–	–	–	–	–	–	●
On/Off	–	–	–	–	–	–	–	–	–	–	–	●
Raise/Lower	–	–	–	–	–	–	–	–	–	–	–	●
Light Off	–	–	–	–	–	–	–	–	–	–	–	●
Toggle	–	–	–	–	–	–	–	–	–	–	–	●

Operating the components connected to the receiver

You can control components connected to the receiver using the “Menu” and “10 key” features of Quick Click.

The following explanation provides examples of normal operation. The component may work differently, or may not work at all depending on the component.

Menu tab

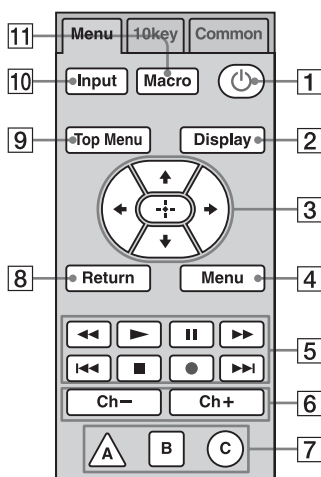

Button	Function
1	Select to turn components connected to the receiver on or off.
2 Display (Info)	Select to display the current status of or information on components connected to the receiver.
3	Select /// to select menu items. Then press to enter the selection.
4 Menu	Select to display the menu of components connected to the receiver.

Button	Function
5	Select to start playback or to record.
	Select to stop or pause playback or recording.
	Select to fast-forward or fast-backward.
	Select to jump to the next/previous track.
6 Ch+/Ch-	Select Ch +/- to select the channel of the TV, satellite tuner, VCR, etc.
7 A/B/C	Select when you operate a cableTV tuner.
8 Return (Exit)	Select to return to the previous menu or exit the menu.
9 Top Menu (Guide)	Select to display the top menu of the DVD player or Blu-ray Disc Player, etc or display the program guide of a TV, satellite tuner or hard disk recorder, etc.
10 Input	Select the input source of the components connected to the receiver.
11 Macro	Select to start a macro programmed with Quick Click. When there are no programmed macros, this button does not appear.

10 key tab

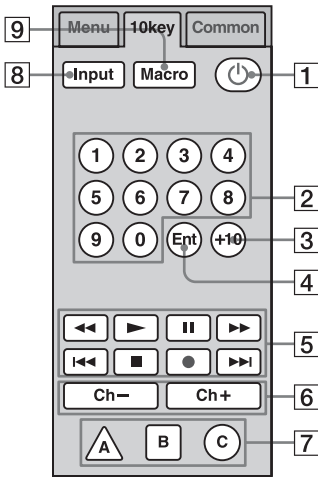

Button	Function
1	Select to turn components connected to the receiver on or off.
2 10 key	Select to <ul style="list-style-type: none"> select track numbers of the CD player, DVD player, Blu-ray Disc Player, or MD deck. select channel numbers of the TV, Satellite tuner or the VCR.
3 +10 (.)	Select to <ul style="list-style-type: none"> select track numbers over 10 of the CD player, DVD player, Blu-ray Disc Player, or MD deck. select channel numbers over 10 of the TV, Satellite tuner or the VCR.
4 Ent	Press to enter the value after selecting a channel, disc or track using the numeric buttons.

Button	Function
5	Select to start playback or to record.
	Select to stop or pause playback or recording.
	Select to fast-forward or fast-backward.
	Select to jump to the next/previous track.
6 Ch+/Ch-	Select Ch +/- to select the channel of the TV, satellite tuner, VCR, etc.
7 A/B/C	Select when you operate a cableTV tuner.
8 Input	Select the input source of components connected to the receiver.
9 Macro	Select to start a macro programmed with Quick Click. When there are no programmed macros, this button does not appear.

Operating the TV, projector or lighting

To operate the TV, select (☐) on Common tab.

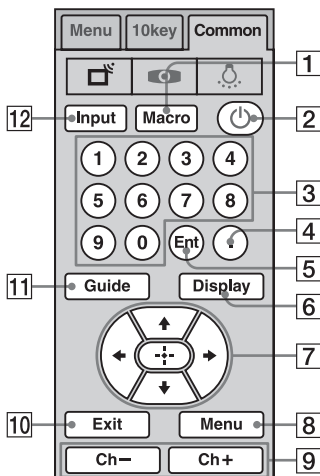

Button	Function
1 Macro	Select to start a macro programmed with Quick Click. When there are no programmed macros, this button does not appear.
2	Select to turn components connected to the receiver on or off.
3 10 key	Select to select channel numbers of the TV, Satellite tuner or the VCR.
4 . (+10)	Select to select channel numbers over 10 of the TV, Satellite tuner or the VCR.
5 Ent	Press to enter the value after selecting a channel, disc or track using the numeric buttons.
6 Display (Info)	Select to display the current status of or information on components connected to the receiver.

Button	Function
7	Select // to select menu items. Then press to enter the selection.
8 Menu	Select to display the menu of the components connected to the receiver.
9 Ch+/Ch-	Select Ch +/- to select the channel of the TV, satellite tuner, VCR, etc.
10 Exit	Select to exit the menu.
11 Guide	Select to display the program guide of a TV, satellite tuner, hard disk recorder, etc.
12 Input	Select the input source of the components connected to the receiver.

To operate the projector, select (👁) on Common tab.

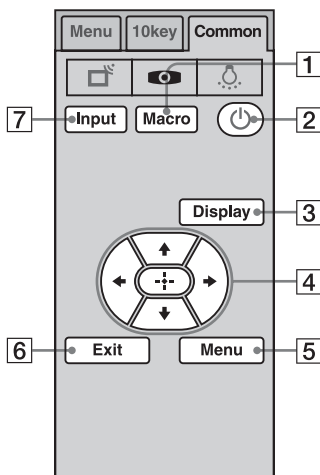

Button	Function
1 Macro	Select to start a macro programmed with Quick Click. When there are no programmed macros, this button does not appear.

Button	Function
2	Select to turn components connected to the receiver on or off.
3 Display (Info)	Select to display the current status of or information on components connected to the receiver.
4 	Select to select menu items. Then press to enter the selection.
5 Menu	Select to display the menu of components connected to the receiver.
6 Exit	Select to exit the menu.
7 Input	Select the input source of the components connected to the receiver.

Button	Function
3 All Off	Select to turn down the brightness of all the lights to the minimum (putting out the lights).
4 Off	Select to turn off a single light.
5 Lower	Select to turn down the brightness of all the lights at the same time.
6 Toggle	Select to switch the preset lighting pattern.
7 Raise	Select to turn up the brightness of all the lights at the same time.
8 On	Select to turn on a single light.
9 All On	Select to turn up all the lights to maximum brightness.
10 Macro	Select to start a macro programmed with Quick Click. When there are no programmed macros, this button does not appear.

To operate the lighting, select on Common tab.

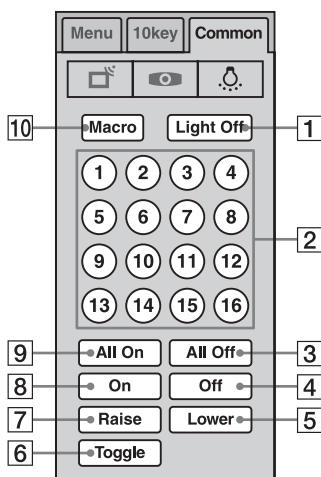

* A lighting control unit is a device which can adjust the brightness of two or more lights with a one-touch operation. Consult your installation dealer about lighting control unit installation.

To make the on-screen remote disappear

Press QUICK CLICK or RETURN/EXIT .

Button	Function
1 Light Off	Select to turn off the power of the lighting control unit.*
2 Scene 1~16	Select to select a preset lighting pattern.

Setting components that are operated by the on-screen remote

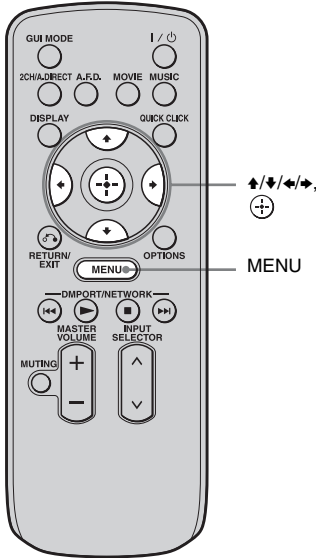

- 1 Press MENU.**
The menu is displayed on the TV screen.
- 2 Press \uparrow/\downarrow repeatedly to select “Settings,” then press \rightarrow or \leftarrow .**
- 3 Press \uparrow/\downarrow repeatedly to select “Quick Click,” then press \rightarrow or \leftarrow .**
- 4 Press \uparrow/\downarrow repeatedly to select “Source Component,” or “Common Component,” then press \rightarrow .**
- 5 Press \uparrow/\downarrow repeatedly to select the component you want, then press \rightarrow .**

- 6 Press \uparrow/\downarrow repeatedly to select “Preset Mode,” then press \rightarrow .**
- 7 Press \uparrow/\downarrow repeatedly to select the input (including a TV) for the component you want to set up, then press \rightarrow .**
- 8 Press \uparrow/\downarrow repeatedly to select the maker name, then press \rightarrow .**
- 9 Press \uparrow/\downarrow repeatedly to select the code, then press \rightarrow .**
If you want to have a test, select “Play” on the TV screen.
- 10 Press $\uparrow/\downarrow/\leftarrow/\rightarrow$ repeatedly to select “Finish,” then press \rightarrow .**

The maker list of the corresponding component

TV (for USA/Canadian model)

SONY	ABEX
ADMIRAL	ADVENT
ADVENTURA	AIWA
AKAI	A MARK
ANAM	AOC
APEX	ARCHER
AUDINAC	AUDIOVOX
BELL & HOWELL	BROKSONIC
CANDLE	CCE
CINERAL	CITIZEN
COBY	CRAIG
CROSLEX	CROWN
CTX	CURTIS MATHIS
DAEWOO	DAYTRON
DUKANE	DURABRAND
EMERSON	EMPREX
ESA	FISHER
FUJITSU	FUNAI
GE	GOLDSTAR
GRADIENTE	HAIER
HITACHI	HP
ILO	INSIGNIA
JANEIL	JC PENNEY

JENSEN	JVC
KLOSS	KLOSS NOVABEAM
KONKA	KTV
LG	LXI
MAGNAVOX	MARANTZ
MAXENT	MEGATRON
MEMOREX	MGA
MINUTZ	MITSUBISHI
MOTOROLA	NAD
NEC	NOBLEX
NORCENT	OLEVIA
OPTIMUS	OPTONICA
ORION	PANASONIC
PHILCO	PHILIPS
PIONEER	POLAROID
PORTLAND	PRINCETON
PROSCAN	PROTON
PROTRON	PROVIEW
QUASAR	RADIO SHACK
RCA	REALISTIC
RUNCO	SAMPO
SAMSUNG	SANSUI
SANYO	SCOTT
SEARS	SEMP TOSHIBA
SERIE DORADA	SHARP
SIGNATURE 2000	SOUNDESIGN
SPECTRICON	SUPREMACY
SVI	SYLVANIA
SYMPHONIC	SYNTAX BRILLIAN
TANDY	TATUNG
TECHWOOD	TEKNICA
TERA	TOSHIBA
TRUTECH	UNIVERSAL
VIDECH	VIEWSONIC
VIKING	VISCO
VIZIO	WARDS
WESTINGHOUSE	ZENITH
ZONDA	

TV (for European model)

SONY	AIWA
AKAI	AUDIO SONIC
B&O	BLAUPUNKT
BRIONVEGA	BUSH
CROWN	DAEWOO
DUAL	FENNER
FERGUSON	GOLDSTAR

GOODMANS	GRUNDIG
HANSOL	HITACHI
HOHER	HYPER
INNO-HIT	IRRADIO
JVC	KENDO
LG	LOEWE
LUXOR	MARK
MATSUI	MITSUBISHI
MIVAR	MIVER
NEC	NOKIA
NOKIA OCEANIC	NORDMENDE
OKANO	ORION
PANASONIC	PHILIPS
PIONEER	ROADSTAR
SABA	SABA, TELEFUNKEN
SAMSUNG	SANYO
SCHNEIDER	SELECO
SHARP	TELEFUNKEN
THOMSON	TOSHIBA
UNITED	VIETA

Projector

SONY	EPSON
MITSUBISHI	OLYMPUS
OPTOMA	RUNCO
SHARP	

VCR (for USA/Canadian model)

SONY	ADMIRAL
AIWA	AKAI
AUDIO DYNAMICS	BELL & HOWELL
BROKSONIC	CANON
CCE	CINERAL
CINEVISION	CITIZEN
CRAIG	CURTIS MATHIS
DAEWOO	DBX
DIMENSIA	EMERSON
FISHER	FUNAI
GE	GO VIDEO
GOLDSTAR	GRADIENTE
HITACHI	HQ
INSIGNIA	INSTANT REPLAY
JC PENNY	JVC
KENWOOD	LG
LITE-ON	LXI
MAGNAVOX	MARANTZ
MARTA	MEMOREX

continued

MGA	MINOLTA
mitsubishi	MULTITECH
NEC	NOKIA
OLYMPIC	OPTIMUS
ORION	PANASONIC
PENTAX	PHILCO
PHILIPS	PIONEER
PROSCAN	QUASAR
RCA	REALISTIC
SAMSUNG	SANSUI
SANYO	SCOTT
SEARS	SEMP TOSHIBA
SENSORY SCIENCE	SHARP
SHINTOM	SIGNATURE 2000
SINGER	SYLVANIA
SYMPHONIC	TASHIRO
TATUNG	TEAC
TECHNICS	TOSHIBA
WARDS	YAMAHA
ZENITH	

VCR (for European model)

SONY	AIWA
AKAI	CGM
FENER	FUNAI
GOLDSTAR	GRUNDIG
HITACHI	JVC
LOEWE	NOKIA
NORDMENDE	OKANO
PANASONIC	PHILIPS
PHONOLA	SAMSUNG
SANYO	SELECO
SHARP	SIEMENS
TELEFUNKEN	TOSHIBA
W.W.HOUSE	WATSON

BD/DVD player (for USA/ Canadian model)

SONY	ADVENT
AIWA	APEX
BROKSONIC	CINEVISION
CLASSIC	COBY
CYBER HOME	DAEWOO
DENON	EMERSON
FUNAI	GO VIDEO
GPX	HARMAN/KARDON
HITACHI	HUMAX

ILO	INSIGNIA
JVC	KENWOOD
KLH	KOSS
KRELL	LG
LITE-ON	MAGNAVOX
MARANTZ	mitsubishi
NORCENT TECHNOLOGY	ONKYO
OPTOMA	ORION
ORITRON	PANASONIC
PHILIPS	PIONEER
RCA	SAMSUNG
SANSUI	SANYO
SHARP	SHINCO
SYLVANIA	SYMPHONIC
TEAC	TERAPIN
THOMSON	TOSHIBA
YAMAHA	ZENITH

BD/DVD player (for European model)

SONY	AIWA
BOSE	CAT
CHESTRON	CYBERHOME
D.I.K.	DAEWOO
DENON	ELTA
GRUNDIG	HARMAN/KARDON
HITACHI	JAMO
JVC	KENWOOD
KLH	MATSUI
MITSUBISHI	MUSTEK
NAKAMICHI	ONKYO
PANASONIC	PHILIPS
PIONEER	PRIMAS
RCA	SAMSUNG
SHARP	SHINCO
SYLVANIA	TEAC
THOMSON	TOSHIBA
YAMAHA/DENON	ZENITH

LD player

SONY	HITACHI
KENWOOD	MAGNAVOX
PANASONIC	PHILIPS
PIONEER	SANYO
SHARP	

CD player (for USA/Canadian model)

SONY	ADMIRAL
AIWA	AKAI
B&O	CROWN
DAEWOO	DENON
EMERSON	FISHER
GOLDSTAR	HARMAN/KARDON
HITACHI	INSIGNIA
JENSEN	JVC
KENWOOD	LG
MAGNAVOX	MARANTZ
MCINTOSH	NAD
NAKAMICHI	ONKYO
OPTIMUS	PANASONIC
PHILIPS	PIONEER
RCA	SABA
SAMSUNG	SANSUI
SANYO	SCHNEIDER
SHARP	SHERWOOD
SOUNDESIGN	T+A
TECHNICS	TOSHIBA
YAMAHA	

CD player (for European model)

SONY	AIWA
CARVER	DAEWOO
DENON	FISHER
GRUNDIG	HARMAN
HITACHI	JVC
KENWOOD	LG
NAD	NAKAMICHI
ONKYO	PANASONIC
PHILIPS	PIONEER
QUADRAL	SABA
SAMSUNG	SANYO
SHERWOOD	SHERWOOD
TECHNICS	UHER
YAMAHA	

MD deck

SONY	AIWA
AKAI	DENON
JVC	KENWOOD
MARANTZ	ONKYO
PANASONIC	PIONEER

SANSUI	SHARP
TEAC	YAMAHA

Cable box

SONY	ABC
ADELPHIA	ADVANCED NEWHOUSE
ALTRIO	AMERICAST
ATLANTIC BROADBAND	BELL SOUTH
BLUE RIDGE	BRIGHT HOUSE
CABLEVISION	CHARTER
COMCAST	COX
GENERAL INSTRUMENT	GNC
HAMLIN	ILLICO
JERROLD	MEMOREX
MOTOROLA	NET
OAK	PACE
PANASONIC	PARAGON
PHILIPS	PIONEER
PULSAR	REGAL
RODGERS	RUNCO
SCIENTIFIC ATLANTA	SEREN
SIGECOM	SUSQUEHANNA
TIME WARNER	TOCOM
TOSHIBA	VIDEOTRON
WIDEOPENWEST	ZENITH

Satellite tuner (box) (for USA/Canadian model)

SONY	CROSSDIGITAL
DIRECTV	DISH NETWORK
ECHOSTAR	GE
GENERAL INSTRUMENT	HITACHI
HUGHES	HUMAX
JVC	MAGNAVOX
MEMOREX	PANASONIC
PAYSAT	PHILIPS
PROSCAN	RCA
SAMSUNG	STAR SIGHT
SYLVANIA	TOSHIBA
UNIDEN	USDIGITAL

Satellite tuner (box) (for European model)

SONY	AMSTRAD
AMSTRAD/RADIX	B SKY B
CANAL +	GALAXIS

continued

GOLD BOX	GRUNDIG
HYUNDAI	JERROLD
KATHREIN	MATSUI
NIKKO	NOKIA
NTV PLUS 2000	PACE
RADIX	SABA
SABA/THOMSON	SKY MASTER
TECHNISAT	WATSON
ZEHNDER	

Digital Video Recorder

SONY	HUMAX
LG	PANASONIC
PHILIPS	PIONEER
REPLAYTV	TIVO
TOSHIBA	

Lighting control

LUTRON(Grafik Eye)	LUTRON(HomeWorks)
LUTRON(RadioRA)	LUTRON(Sivoia Shades)
LUTRON(Spacer)	LUTRON(Spacer System)
X10	

Tape deck (for USA/Canadian model)

SONY	AIWA
DENON	FISHER
GOLDSTAR	HARMAN/KARDON
JVC	KENWOOD
LG	MARANTZ
NAD	NAKAMICHI
ONKYO	PANASONIC
PHILIPS	PIONEER
RCA	SANSUI
SANYO	SHARP
TEAC	TECHNICS
YAMAHA	

Tape deck (for European model)

SONY	AIWA
AKAI	B&O
DENON	HARMAN
JVC	KENWOOD
LG	MARANTZ
MATSUI	MISSION
NAD	ONKYO
PHILIPS	PIONEER
QUADRAL	REVOX
SANYO	SCHNEIDER
SHERWOOD	T+A
TEAC	TECHNICS
UHER	YAMAHA

Performing several commands in sequence automatically with Quick Click (Macro Play)

You can use the macro function easily with Quick Click.

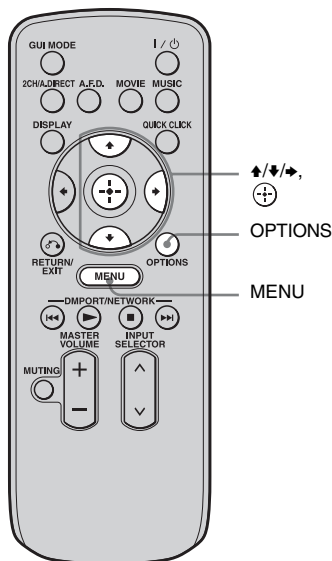

- 1 Press MENU.**
The menu is displayed on the TV screen.
- 2 Press ▲/▼ repeatedly to select “Settings,” then press ⊕ or ▶.**
- 3 Press ▲/▼ repeatedly to select “Quick Click,” then press ⊕ or ▶.**
- 4 Press ▲/▼ repeatedly to select “Macro Setup,” then press ⊕.**
- 5 Press ▲/▼ repeatedly to select the macro number for which**

you want to program the sequence of operation(s), then press ⊕.

- 6 Press ▲/▼ repeatedly to select the step number you want to set, then press ⊕.**
- 7 Press ▲/▼ repeatedly to select the component you want, then press ▶.**
- 8 Press ▲/▼ repeatedly to select the key, then press ▶.**
- 9 Press ▲/▼ repeatedly to select the duration of time you want, then press ⊕.**
- 10 Repeat steps 6 to 9 when you want to program operations for other components.**
- 11 Press ▲/▶/▶ to select Step Interval, then press ⊕.**
- 12 Press ▲/▼ repeatedly to select the step interval time you want to set, then press ⊕.**
- 13 Press ▲/▶/▶ repeatedly to select “Finish,” then press ⊕.**
The settings process is complete.

To cancel programming

Press ▲/▼/▶/▶ to select “Cancel,” then press ⊕.

Starting macro play

1 Press QUICK CLICK.

The on-screen remote is displayed on the TV screen.

2 Press $\uparrow/\downarrow/\leftarrow/\rightarrow$ to select MACRO on on-screen remote.

The macro list appears on the TV screen.

3 Press \uparrow/\downarrow to select the macro number you want to start.

The macro starts and executes the commands in the order you assigned them.

To input a macro name

1 Press MENU.

The menu is displayed on the TV screen.

2 Press \uparrow/\downarrow repeatedly to select “Settings,” then press \oplus or \rightarrow .

3 Press \uparrow/\downarrow repeatedly to select “Quick Click,” then press \oplus or \rightarrow .

4 Press \uparrow/\downarrow repeatedly to select “Macro Setup,” then press \oplus .

5 Press OPTIONS.

The option menu appears.

6 Press \oplus to select “Name Input.” The soft keyboard appears on the TV screen.

7 Press $\uparrow/\downarrow/\leftarrow/\rightarrow$ and \oplus to select a character one by one.

8 Press $\uparrow/\downarrow/\leftarrow/\rightarrow$ to select “Finish,” then press \oplus . The name you entered is registered.

To cancel naming input

Press $\uparrow/\downarrow/\leftarrow/\rightarrow$ to select “Cancel,” then press \oplus .

To erase a programmed macro

1 Press MENU.

The menu is displayed on the TV screen.

2 Press \uparrow/\downarrow repeatedly to select “Settings,” then press \oplus or \rightarrow .

3 Press \uparrow/\downarrow repeatedly to select “Quick Click,” then press \oplus or \rightarrow .

4 Press \uparrow/\downarrow repeatedly to select “Macro Setup,” then press \oplus .

5 Press \uparrow/\downarrow repeatedly to select the macro number you want, then press \oplus .

6 Press \uparrow/\downarrow repeatedly to select the step number you want, then press \oplus .

7 Press \uparrow/\downarrow repeatedly to select “-” as a component name, then press \oplus .

8 Repeat steps 7 and 8 to clear the stored macro.

9 Press $\uparrow/\downarrow/\leftarrow/\rightarrow$ repeatedly to select “Finish,” then press \oplus . Settings stored as a macro are cleared.

Setting remote control codes that are not stored in Quick Click

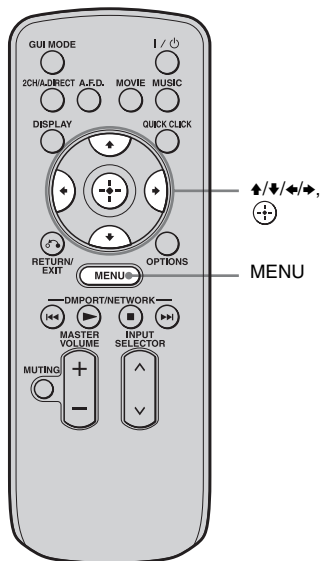

- 1 Press MENU.**
The menu is displayed on the TV screen.
- 2 Press \uparrow/\downarrow repeatedly to select “Settings,” then press \leftarrow or \rightarrow .**
- 3 Press \uparrow/\downarrow repeatedly to select “Quick Click,” then press \leftarrow or \rightarrow .**
- 4 Press \uparrow/\downarrow repeatedly to select “Source Component,” or “Common Component,” then press \leftarrow .**
- 5 Press \uparrow/\downarrow repeatedly to select the component you want, then press \leftarrow .**

- 6 Press \uparrow/\downarrow repeatedly to select “Learn Mode,” then press \leftarrow .**
- 7 Press \uparrow/\downarrow repeatedly to select the code number you want to store as the new command, then press \leftarrow .**
- 8 Keep pressing the corresponding button on the remote of the component to be programmed while pointing the remote toward the receiver’s remote sensor until “Complete” is displayed on the TV screen.**

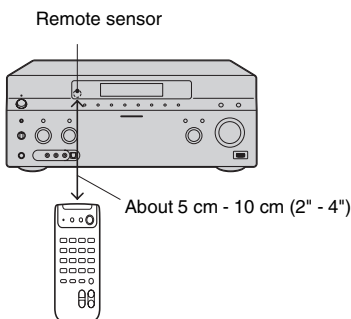

- “Test” is selected automatically after few seconds when the registration of a new code is completed.
- 9 Press \leftarrow .**
The operation test of the programmed code is started.
Proceed to step 10 if you will not perform the operation test.
 - 10 Press $\uparrow/\downarrow/\leftarrow/\rightarrow$ repeatedly to select “Finish,” then press \leftarrow .**

Note
The display window is turned off while the receiver is registering the new code.

To use a command that has been learned

- 1 Press MENU.
The menu is displayed on the TV screen.
- 2 Press \uparrow/\downarrow repeatedly to select "Input," then press \leftarrow or \rightarrow .
- 3 Press \uparrow/\downarrow repeatedly to select the component you want, then press \leftarrow .
- 4 Press QUICK CLICK.
- 5 Press $\uparrow/\downarrow/\leftarrow/\rightarrow$ to select the button on the on-screen remote used to learn that function, then press \leftarrow .

Resetting the remote code for Quick Click

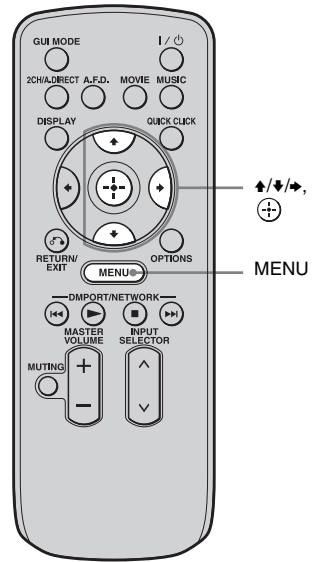

- 1 Press MENU.
The menu is displayed on the TV screen.
- 2 Press \uparrow/\downarrow repeatedly to select "Settings," then press \leftarrow or \rightarrow .
- 3 Press \uparrow/\downarrow repeatedly to select "Quick Click," then press \leftarrow or \rightarrow .
- 4 Press \uparrow/\downarrow repeatedly to select "Source Component," or "Common Component," then press \leftarrow .
- 5 Press \uparrow/\downarrow repeatedly to select the component you want, then press \leftarrow .

6 Press **▲/▼** repeatedly to select “Reset,” then press **⊕**.

The confirming message appears on the TV screen.

7 Press **▲/▼** repeatedly to select “Yes,” then press **⊕**.

All the contents of the selected input (e.g., all the programmed data) are cleared.

8 Repeat steps 5 to 7 to clear all programmed data.

Note

The macro itself is not cleared. A default code will be output when you have set a preset code or learned code in the macro step.

Operating Each Component Using the Multifunction Remote

Operating each component using the multifunction remote

You can control Sony or non-Sony components you are using with the multifunction remote supplied with the receiver.

The remote is initially set to control Sony components.

When you change the settings of the remote according to the components you are using, you can control non-Sony and other Sony components that the remote is initially unable control (page 172).

Operating the components connected to the receiver

- 1 Press the input button that matches the connected component that you want to operate.**
- 2 Press the appropriated buttons to use the function listed in the table below.**

Note

You may not be able to operate some functions for the components you are using.

Table of buttons used to control each component

Component	TV	VCR	DVD player, DVD/VHS Player combo	Blu-ray Disc Player	HDD Recorder	PSX	Video CD player, LD player	Digital CATV terminal *5	DSS *5	Digital Satellite/ Terrestrial receiver*6	Tape deck A/B	DAT deck	CD player, MD deck	DIGITAL MEDIA PORT device
AV I/O	●	●	●	●	●	●	●	●	●	●		●	●	
Numeric buttons	●	●	●	●	●	●	●	●	●	●	●	●	●	●
TV INPUT, WIDE	●													
-/-	●	●	●	●	●	●	●	●	●		●		●	
ENT/MEM	●	●	●	●	●	●	●*1	●	●		●	●	●	
CLEAR			●	●	●	●			●				●	
TOOLS/OPTIONS	●		●	●	●	●		●	●					
DISPLAY	●	●	●	●	●	●	●	●	●				●	
RETURN/EXIT	●		●	●	●	●	●	●	●	●				●
⬆/⬇/⬅/⬄, ⊕, MENU, HOME	●	●	●	●	●	●		●	●	●				●
⏮/⏪/⏩/⏭	●	●	●	●	●	●	●	●			●*2	●	●	●
⏪/⏩	●		●	●	●	●		●						●
⏮/TUNING -, ⏭/TUNING +	●	●	●	●	●	●	●	●			●	●	●	●
DISC SKIP			●*3	●			●*4						●	
▶, II, ■	●	●	●	●	●	●	●	●			●	●	●	●
MUTING, MASTER VOL +/-, TV VOL +/-	●													
PRESET +/-, TV CH +/-	●	●	●	●	●		●*1	●	●	●				
BD/DVD TOP MENU, BD/DVD MENU			●	●		●								
F1, F2			●	●										

*1 LD player only

*2 Deck B only

*3 DVD only

*4 Video CD only

*5 USA/Canadian model only

*6 European model only

Programming the remote

You can customize the remote to match the components connected to your receiver. You can even program the remote to control non-Sony components and also Sony components that the remote is normally unable to control. The procedure below uses as an example a case in which a VCR made by a company other than Sony is connected to the VIDEO 2 IN jacks on the receiver.

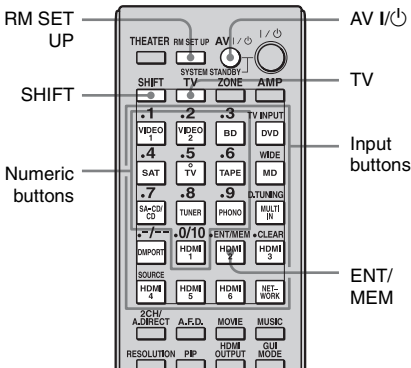

1 Press AV I/O while pressing RM SET UP.

The RM SET UP button flashes.

2 While the RM SET UP button is flashing, press the input button (including the TV button) for the component you want to control.

For example, if you are going to control a VCR connected to VIDEO 2 IN jack, press VIDEO 2.

RM SET UP and the input button light up. If you press the button for a component of which you cannot program the remote, such as TUNER, PHONO, DMPRT or SOURCE, etc., the RM SET UP button keeps flashing.

3 Press the numeric buttons to enter the numeric code (or one of the codes if more than one

code exists) corresponding to the component and the maker of the component you want to control.

The input button lights up.

Note

As a remote code value for the TV button, only numbers in the 500's are valid.

4 Press ENT/MEM.

Once the numeric code has been verified, the RM SET UP button flashes twice and the remote automatically exits the programming mode. The input button also turns off.

To cancel programming

Press RM SET UP during any step.

The numeric codes corresponding to the component and the maker of the component

Use the numeric codes in the tables below to control non-Sony components and also Sony components that the remote is normally unable to control. Since the remote signal that a component accepts differs depending on the model and year of the component, more than one numeric code may be assigned to a component. If you fail to program your remote using one of the codes, try using other codes.

Notes

- The numeric codes are based on the latest information available for each brand. There is a chance, however, that your component will not respond to some or all of the codes.
- All of the input buttons on this remote may not be available when used with your particular component.

To control a CD player

Maker	Code(s)
SONY	101, 102, 103
DENON	104, 123
JVC	105, 106, 107
KENWOOD	108, 109, 110
MAGNAVOX	111, 116
MARANTZ	116
ONKYO	112, 113, 114
PANASONIC	115
PHILIPS	116
PIONEER	117
TECHNICS	115, 118, 119
YAMAHA	120, 121, 122

To control a DAT deck

Maker	Code(s)
SONY	203
PIONEER	219

To control a tape deck

Maker	Code(s)
SONY	201, 202
DENON	204, 205
KENWOOD	206, 207, 208, 209
NAKAMICHI	210
PANASONIC	216
PHILIPS	211, 212
PIONEER	213, 214
TECHNICS	215, 216
YAMAHA	217, 218

To control an MD deck

Maker	Code(s)
SONY	301
DENON	302
JVC	303
KENWOOD	304

To control an HDD recorder

Maker	Code(s)
SONY	307, 308, 309

To control a Blu-ray Disc Player

Maker	Code(s)
SONY	310, 311, 312

To control a PSX

Maker	Code(s)
SONY	313, 314, 315

To control a DVD player

Maker	Code(s)
SONY	401, 402, 403
BROKSONIC	424
DENON	405
HITACHI	416
JVC	415, 423
MITSUBISHI	419
ORITRON	417
PANASONIC	406, 408, 425
PHILIPS	407
PIONEER	409, 410
RCA	414
SAMSUNG	416, 422
TOSHIBA	404, 421
ZENITH	418, 420

To control a DVD/VIDEO COMBO (recorder)

Maker	Code(s)
SONY	411

To control a HDD/DVD COMBO (recorder)

Maker	Code(s)
SONY	401, 402, 403

To control a TV

Maker	Code(s)
SONY	501
AIWA	501, 536, 539
AKAI	503
AOC	503
CENTURION	566
CORONADO	517
CURTIS-MATHES	503, 551, 566, 567
DAYTRON	517, 566
DAEWOO	504, 505, 506, 507, 515, 544
FISHER	508, 545
FUNAI	548
FUJITSU	528

Maker	Code(s)
GOLDSTAR/LG	503, 512, 515, 517, 534, 544, 556, 568, 576
GRUNDIG	511, 533, 534
HITACHI	503, 513, 514, 515, 517, 519, 544, 557, 571
ITT/NOKIA	521, 522
J.C.PENNY	503, 510, 566
JVC	516, 552
KMC	517
MAGNAVOX	503, 515, 517, 518, 544, 566
MARANTZ	527
MITSUBISHI/MGA	503, 519, 527, 544, 566, 568
NEC	503, 517, 520, 540, 544, 554, 566
NORDMENDE	530, 558
NOKIA	521, 522, 573, 575
PANASONIC	509, 524, 553, 559, 572
PHILIPS	515, 518, 557, 570, 571
PHILCO	503, 504, 514, 517, 518
PIONEER	509, 525, 526, 540, 551, 555
PORTLAND	503
QUASAR	509, 535
RADIO SHACK	503, 510, 527, 565, 567
RCA/PROSCAN	503, 510, 523, 529, 544
SAMSUNG	503, 515, 517, 531, 532, 534, 544, 556, 557, 562, 563, 566, 569
SAMPO	566
SABA	530, 537, 547, 549, 558
SANYO	508, 545, 546, 560, 567
SCOTT	503, 566
SEARS	503, 508, 510, 517, 518, 551
SHARP	517, 535, 550, 561, 565
SYLVANIA	503, 518, 566
THOMSON	530, 537, 547, 549
TOSHIBA	535, 539, 540, 541, 551
TELEFUNKEN	530, 537, 538, 547, 549, 558
TEKNIKA	517, 518, 567
WARDS	503, 517, 566
YORK	566
ZENITH	542, 543, 567
GE	503, 509, 510, 544
LOEWE	515, 534, 556

To control an LD player

Maker	Code(s)
SONY	601, 602, 603
PIONEER	606

To control a video CD player

Maker	Code(s)
SONY	605

To control a VCR

Maker	Code(s)
SONY	701, 702, 703, 704, 705, 706
AIWA*	710, 750, 757, 758
AKAI	707, 708, 709, 759
BLAUPUNKT	740
EMERSON	711, 712, 713, 714, 715, 716, 750
FISHER	717, 718, 719, 720
GENERAL ELECTRIC (GE)	721, 722, 730
GOLDSTAR/LG	723, 753
GRUNDIG	724
HITACHI	722, 725, 729, 741
ITT/NOKIA	717
JVC	726, 727, 728, 736
MAGNAVOX	730, 731, 738
MITSUBISHI/MGA	732, 733, 734, 735
NEC	736
PANASONIC	729, 730, 737, 738, 739, 740
PHILIPS	729, 730, 731
PIONEER	729
RCA/PROSCAN	722, 729, 730, 731, 741, 747
SAMSUNG	742, 743, 744, 745
SANYO	717, 720, 746
SHARP	748, 749
TELEFUNKEN	751, 752
TOSHIBA	747, 756
ZENITH	754

* If an AIWA VCR does not work even though you enter the code for AIWA, enter the code for Sony instead.

To control a satellite tuner (box)

Maker	Code(s)
SONY	801, 802, 803, 804, 824, 825, 865

Maker	Code(s)
AMSTRAD	845, 846
BskyB	862
GENERAL ELECTRIC(GE)	866
GRUNDIG	859, 860
HUMAX	846, 847
THOMSON	857, 861, 864, 876
PACE	848, 849, 850, 852, 860, 863, 864
PANASONIC	818, 855
PHILIPS	856, 857, 858, 859, 860, 864, 874
NOKIA	851, 853, 854, 864
RCA/PROSCAN	866, 871
HITACHI/BITA	868
HUGHES	867
JVC/Echostar/Dish Network	873
MITSUBISHI	872
SAMSUNG	875
TOSHIBA	869, 870

To control a cable box

Maker	Code(s)
SONY	821, 822, 823
HAMLIN/REGAL	836, 837, 838, 839, 840
JERROLD/G.I./MOTOROLA	806, 807, 808, 809, 810, 811, 812, 813, 814, 819
JERROLD	830, 831
OAK	841, 842, 843
PANASONIC	816, 826, 832, 833, 834, 835
PHILIPS	830, 831
PIONEER	828, 829
RCA	805
SCIENTIFIC ATLANTA	815, 816, 817
TOCOM/PHILIPS	830, 831
ZENITH	826, 827

Performing several commands in sequence automatically

(Macro Play)

The Macro Play function lets you link several commands in a sequential order as a single command.

The remote provides 2 macro lists (MACRO 1 and MACRO 2). You can specify up to 20 commands for each macro list.

Note

When setting up Macro Play, replace the batteries with new ones.

Program the sequence of the operation

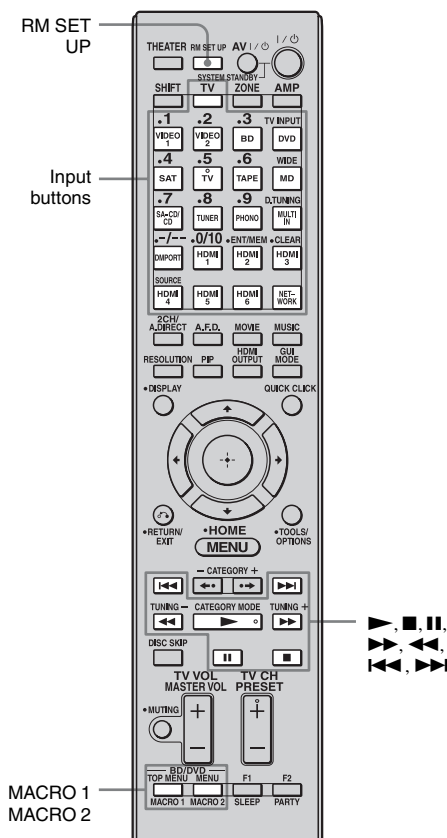

- 1 Press MACRO 1 or MACRO 2 for more than 1 second while pressing RM SET UP.**

The RM SET UP button flashes and one of the input buttons lights up (as the initial setting, the VIDEO1 button lights).

- 2 Press the input button for the component for which you want to program the sequence of operation(s).**

- 3 Press the buttons you want to program in the same sequence as you want the operation(s) to be performed.**

Press	Operations to be programmed
-------	-----------------------------

▶, ■, ■, ■	Performs the operation of the button.
------------	---------------------------------------

▶▶, ◀◀, ◀◀, ▶▶	The input button for more than 1 second
----------------	---

MACRO 1 or MACRO 2	Make a one second interval. When you want to make a longer interval, press MACRO 1 or MACRO 2 repeatedly.
--------------------	---

The input button selected in step 2 flashes twice, then lights up again.

- 4 Repeat steps 2 and 3 when you want to program operations for other components.**

- 5 Press RM SET UP to finish the programming process.**

Tip

If the RM SET UP button flashes five times in step 1, and the macro programming process does not start, replace the batteries with new ones.

To cancel programming

Press RM SET UP. Also, not pressing any button for 60 seconds cancels the settings. The previous command remains valid.

Starting macro play

- 1 Press AMP.**
The AMP button lights up, and then turns off.
- 2 Press MACRO 1 or MACRO 2 to start the macro.**
The macro starts and execute the commands in the order you assigned them. While the commands are being sent, the AMP button flashes and the RM SET UP button lights up. When the commands have been sent, the RM SET UP and AMP buttons turn off.

To erase a programmed macro

- 1 Press MACRO 1 or MACRO 2 for more than 1 second while pressing RM SET UP to clear the stored macro.**
The RM SET UP button flashes.
- 2 Press RM SET UP.**
Settings stored as macro are cleared.

Setting remote commander codes that are not stored in the remote

Even if a remote commander code is not one of the presets stored in the remote, it is possible for the remote to learn the code using the learning function.

Note

When setting up the receiver to learn the remote command modes, replace the batteries with new ones.

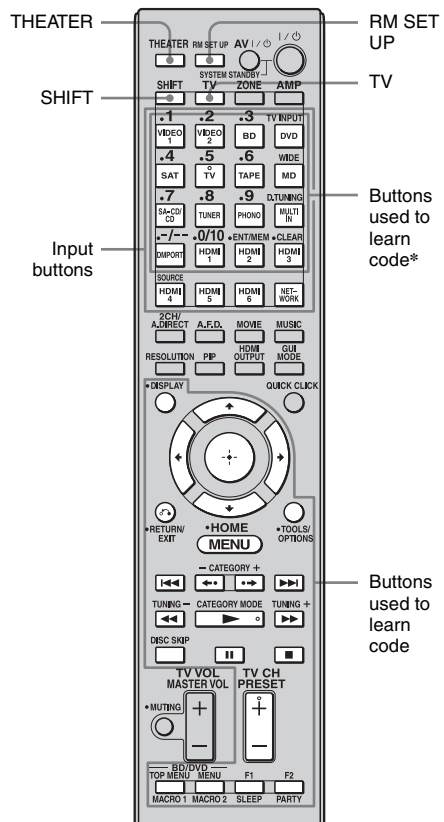

* To store a new command on one of those buttons, press SHIFT beforehand.

1 Press THEATER while pressing RM SET UP.

The RM SET UP button lights up.

2 Press the input button (including the TV button) for the component you want to operate with the new command.

The input button flashes. (The RM SET UP button remains lit.)

3 Press the button on which you want to store the new command. For the buttons with an asterisk in the illustration above, press SHIFT, then press the button.

The input button you selected in step 2 lights up. (The RM SET UP button remains lit.)

4 Point the remote code receiver section of the remote toward the transmitter on the remote commander to be learned from.

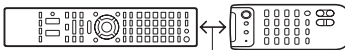

About 5 cm - 10 cm (2" - 4")

5 Press the button on the remote commander to be learned from to transmit the remote code.

While the remote of the receiver is receiving the signal, the input button selected in step 2 turns off.

The RM SET UP button flashes twice, then the learning process is completed.

When the learning process fails, the RM SET UP button flashes five times. Try to perform process again from step 2.

6 Press RM SET UP to finish the Learning function process.

Tips

- When the memory capacity for storing remote commander codes reaches a certain limit, the RM SET UP button flashes 10 times, and then the learning process ends.
- If the RM SET UP button flashes five times in step 1, and the learning process does not start, replace the batteries with new ones.

To cancel learning

Press RM SET UP. Also, not pressing any button for 60 seconds cancels the settings.

Using a command that has been learned

When selecting a learned input, press the button used to learn that function.

To erase the learned code

1 Press THEATER while pressing RM SET UP.

2 Press the input button for which you want to clear the setting.

The input button flashes. (The RM SET UP button remains lit.)

3 Press I/⏻ for more than 1 second.

The input button flashes twice, repeatedly.

4 Press SHIFT, then press numeric buttons to clear the stored setting.

The RM SET UP button flashes twice, then the clearing process is completed.

When the clearing process fails, the RM SET UP button flashes five times. Try to perform process again from step 2.

Clearing all the contents of the remote's memory

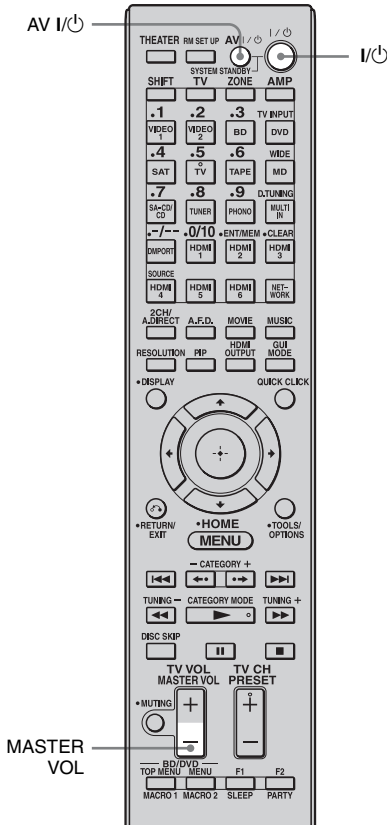

1 Press and hold **MASTER VOL –** first, then press **I/⏻**, then press **AV I/⏻**.

The RM SET UP button flashes three times.

2 Release all buttons.

All the contents of the remote's memory (e.g., all the programmed data) are cleared.

Glossary

■ **Broadband**

General name for communication lines that use a broad frequency bandwidth for sending and receiving large amounts of video or audio data at high speed. Currently, ADSL, CATV, FTTH and other systems are identified as broadband.

■ **Broadband router**

For Internet connections through ADSL or a cable TV line, devices called ADSL modems or cable modems are used. However, for Internet access from multiple terminals connected at once, a broadband router is used.

■ **Component video**

A format for transmitting video signal information consisting of three separate signals: luminance Y, chrominance Pb, and chrominance Pr. High quality pictures, such as DVD video or HDTV pictures, are transmitted more faithfully. The three jacks are color-coded green, blue, and red.

■ **Composite video**

A standard format for transmitting video signal information. The luminance signal Y and chrominance signal C are combined and transmitted together.

■ **Crossover frequency**

The frequency at which two speaker's frequencies intersect.

■ **Deep Color**

Video signals for which the color depth of signals passing through an HDMI jack have been raised.

The number of colors that could be expressed by 1 pixel was 24 bits (16,777,216 colors) with the current HDMI jack. However, the number of colors which can be expressed by 1 pixel will be 36, etc., bits when the receiver corresponds to Deep Color.

Since the gradation of the depth of a color can be expressed more finely with more bits, continuous color changes can be more smoothly expressed.

■ **DHCP**

Abbreviation of Dynamic Host Configuration Protocol.

A set of rules to automatically assign settings necessary for network communication.

■ **Digital Concert Hall**

“Digital Concert Hall” delivers richer sound for 2ch stereo sources such as CDs, etc. With the use of 5.1ch or 7.1ch speakers and virtual speaker technology, stereoscopic reverberation and reflected sound are reproduced, and music software can be enjoyed with richer sound and presence. The sound field in a concert hall is recreated by a geometrical analysis of the concert hall and precise modeling of reflected and reverberant sounds based on actual measured data. Tonal qualities such as sound strength and frequency response are taken into account and calculated on the DSP (Digital Signal Processor) to bring reverberation in. Sound is enjoyed with natural and comfortable resonance, as if listening to music in a concert hall.

■ Digital Legato Linear (D.L.L.)

This is Sony proprietary technology that allows low quality digital audio signals to be played back with high quality sound. Old recording or compressed audio often have noise on the waveform and out-of-frequency distortion, as well as harmonic distortion, in the audio frequency is generated. Therefore beat interference and ringing occur, and such phenomena degrade the sound quality. The D.L.L. feature eliminates these problems, and gives you rich sound for music and movies.

■ DLNA

Abbreviation of Digital Living Network Alliance.

An association that formulates audio/photo/video distribution among PCs and other digital devices in a home network environment, or the format itself.

DLNA certified devices are interoperable with each other, thus making them easy to communicate on the network.

■ DNS

Abbreviation of Domain Name System. A server that translates domain names to IP addresses, or IP addresses to domain names. A DNS is identified by an IP address. Also called a “DNS server.”

■ Dolby Digital

Digital audio encoding/decoding technology developed by Dolby Laboratories, Inc. It consists of front (left/right), center, surround (left/right) and subwoofer channels. It is a designated audio standard for DVD-video and also known as 5.1 channels surround.

■ Dolby Digital Plus

Dolby Digital Plus provides the flexibility and efficiency to deliver more channels of compelling surround sound for high-definition video media. Its superior coding efficiencies enable up to 7.1ch of high-quality multichannel audio without negatively impacting bit budgets allocated for video performance or additional feature sets.

■ Dolby Digital Surround EX

Acoustic technology developed by Dolby Laboratories, Inc. Surround back information is matrixed into regular left and right surround channels so that the sound can be reproduced in 6.1 channels. Active scenes, especially, are recreated with a more dynamic and realistic sound field.

■ Dolby Pro Logic II

This technology converts 2 channels stereo recorded audio into 5.1 channels for playback. Old movies encoded in the traditional stereo format can be enhanced with 5.1 channels surround sound.

■ Dolby Pro Logic IIx

Technology for 7.1 channels (or 6.1 channels) playback. Along with audio encoded in Dolby Digital Surround EX, 5.1 channels Dolby Digital encoded audio can be reproduced in 7.1 channels (or 6.1 channels). Furthermore, existing stereo recorded content can also be reproduced in 7.1 channels (or 6.1 channels).

■ Dolby Surround (Dolby Pro Logic)

Audio processing technology developed by Dolby Laboratories, Inc. Center and mono surround information is matrixed into two stereo channels. When reproduced, audio is decoded and output in 4 channels surround sound. This is the most common audio processing method for DVD-video.

■ Dolby TrueHD

Dolby TrueHD is Dolby’s lossless audio technology developed for high-definition optical discs. Dolby TrueHD audio is bit-for-bit identical to the original studio masters and provides supreme-quality audio up to 8ch at 96 kHz/24 bit and up to 6ch at 192 kHz/24 bit. Together with high-definition video, it offers an unprecedented home theater experience.

■ DSD

Audio format used for a Super Audio CD. DSD converts analog signals to digital and records them directly, without adding any processing, so that no information is omitted. Recording and playback of high fidelity, quality sound is achieved.

■ DTS 96/24

A high sound quality digital signal format. It records audio at a sampling frequency and bit rate of 96 kHz/24 bit which is the highest possible for DVD-video. The number of playback channels varies depending on the software.

■ DTS Digital Surround

Digital audio encoding/decoding technology for theaters developed by DTS, Inc. It compresses audio less than Dolby Digital, delivering a higher quality sound reproduction.

■ DTS Neo:6

This technology converts 2 channels stereo recorded audio for 7 channels playback. There are two modes to select according to the playback source or your preference, CINEMA for movies, and MUSIC for stereo sources such as music.

■ DTS-ES

Format for 6.1 channels playback with surround back information. There are two modes, “Discrete 6.1” which records all channels independently, and “Matrix 6.1” which matrixes surround back channel into surround left and surround right channels. It is ideal for playback of motion picture soundtracks.

■ DTS-HD

Audio format which extends the conventional DTS Digital Surround format.

This format consists of a core and an extension, and the core part has DTS Digital Surround compatibility. There are two kinds of DTS-HD, DTS-HD High Resolution Audio and DTS-HD Master Audio. DTS-HD High Resolution Audio has a maximum transmission rate of 6 Mbps, with lossy compression (Lossy), and DTS-HD High Resolution Audio corresponds to a maximum sampling frequency of 96 kHz, and a maximum of 7.1 ch. DTS-HD Master Audio has a the maximum transmission rate of 24.5 Mbps, and uses lossless compression (Lossless), and DTS-HD Master Audio corresponds to a maximum sampling frequency of 192 kHz, and a maximum of 7.1 ch.

■ Gateway

An IP address of a device such as a computer or a router, etc., which is required when the receiver accesses the Internet or an external network.

■ H.A.T.S. (High quality digital Audio Transmission System) for HDMI

H.A.T.S. for HDMI is a flow control playback system for HDMI transmission.

A master clock, important for audio quality, is provided by a crystal transmitter beside the DA converter of the receiver, and this master clock controls the playback speed of the components connected to the receiver using the HDMI CEC (Consumer Electronics Control) for HDMI (High-Definition Multimedia Interface) to match the playback rate. It gives you high quality sound with exceptional clarity, because, there is nearly no transmission jitter when transmitting the clock.

■ HD Digital Cinema Sound (HD-D.C.S.)

HD Digital Cinema Sound (HD-D.C.S.) is Sony's new innovative home theater technology using the latest acoustic and digital signal processing technologies. It is based on precise response measurement data of a mastering studio.

With HD-D.C.S., you are able to enjoy Blu-ray and DVD movies at home with not only the high quality of sound, but also the best sound ambience, just as the movie's sound engineer intended in the mastering process.

■ HDMI (High-Definition Multimedia Interface)

HDMI (High-Definition Multimedia Interface) is an interface that supports both video and audio on a single digital connection, allowing you to enjoy high quality digital picture and sound. The HDMI specification supports HDCP (High-bandwidth Digital Contents Protection), a copy protection technology that incorporates coding technology for digital video signals.

■ High Bitrate Audio

It refers to the audio formats of the compression method (DTS-HD Master Audio, Dolby TrueHD, etc.) which is a high bitrate format recorded mainly on Blu-ray Disc etc.

■ Interlace

A scanning method which completes a picture by displaying half of the lines on a tube surface of a TV or monitor each 1/60 second. First, all the odd-numbered lines are drawn, leaving spaces between each line, then all the even-numbered lines are drawn to fill the spaces. "i" of "480i" stands for "Interlace."

■ Internet

A communication network linking computers around the world. The Internet supports many services, including email and search engines.

■ L.F.E. (Low Frequency Effects)

Sound effects of low frequencies which are output from a subwoofer in Dolby Digital or DTS, etc. By adding a deep bass with a frequency between 20 to 120 Hz, audio becomes more powerful.

■ LAN

Abbreviation of Local Area Network.

LAN is a general name for networks set up for communication among devices including computers, printers, and fax machines in relatively small areas such as offices or buildings.

■ Neural-THX

Neural Surround™, THX® Technologies has been chosen as the official surround sound broadcast format for XM Satellite Radio's "XM HD Surround" and other leading FM/HD radio stations in the USA and worldwide. Neural Surround, THX Technologies delivers the rich envelopment and discrete image detail of surround sound in a format 100% compatible with stereo.

■ PCM (Pulse Code Modulation)

A method of converting analog audio to digital audio for easy enjoyment of digital sound.

■ Progressive

A scanning method that draws all scanning lines sequentially, as opposed to interlaced scanning where all the odd and then all the even lines are drawn.

"p" of "480p" stands for "Progressive."

■ Router

Device that relays data flow from network to network. Routers are usually installed between the Internet and the home network. Some routers are capable of connecting multiple devices to the Internet.

■ Server

A device which provides content such as music, photos, or videos to clients on your home network.

■ Subnet mask

Part of an IP address that identifies the subnet, a smaller group on the network.

■ x.v.Color

“x.v.Color” enables the more faithful reproduction of various colors such as the brilliant colors of flowers and the turquoise blue of the southern ocean.

Precautions

On safety

Should any solid object or liquid fall into the cabinet, unplug the receiver and have it checked by qualified personnel before operating it any further.

On power sources

- Before operating the receiver, check that the operating voltage is identical with your local power supply.
The operating voltage is indicated on the nameplate on the back of the receiver.
- The unit is not disconnected from the AC power source (mains) as long as it is connected to the wall outlet, even if the unit itself has been turned off.
- If you are not going to use the receiver for a long time, be sure to disconnect the receiver from the wall outlet. To disconnect the AC power cord (mains lead), grasp the plug itself; never pull the cord.
- One blade of the plug is wider than the other for the purpose of safety and will fit into the wall outlet only one way. If you are unable to insert the plug fully into the outlet, contact your dealer.
- AC power cord (mains lead) must be changed only at a qualified service shop.

On heat buildup

Although the receiver heats up during operation, this is not a malfunction. If you continuously use this receiver at a large volume, the cabinet temperature of the top, side and bottom rises considerably. To avoid burning yourself, do not touch the cabinet.

On placement

- Place the receiver in a location with adequate ventilation to prevent heat buildup and prolong the life of the receiver.

- Do not place the receiver near heat sources, or in a place subject to direct sunlight, excessive dust, or mechanical shock.
- Do not place anything on top of the cabinet that might block the ventilation holes and cause malfunctions.
- Do not place the receiver near equipment such as a television, VCR, or tape deck. (If the receiver is being used in combination with a television, VCR, or tape deck, and is placed too close to that equipment, noise may result, and picture quality may suffer. This is especially likely when using an indoor antenna (aerial). Therefore, we recommend using an outdoor antenna (aerial).)

On operation

Before connecting other components, be sure to turn off and unplug the receiver.

On cleaning

Clean the cabinet, panel, and controls with a soft cloth slightly moistened with a mild detergent solution. Do not use any type of abrasive pad, scouring powder, or solvent, such as alcohol or benzine.

If you have any questions or problems concerning your receiver, please consult your nearest Sony dealer.

Troubleshooting

If you experience any of the following difficulties while using the receiver, use this troubleshooting guide to help you remedy the problem. Should any problem persist, consult your nearest Sony dealer.

Audio

There is no sound, no matter which component is selected, or only a very low-level sound is heard.

- Check that the speakers and components are connected securely.
- Check that all speaker cords are connected correctly.
- Check that both the receiver and all components are turned on.
- Check that MASTER VOLUME control is not set at $-\infty$ dB. Try to set it at about -40 dB.
- Check that SPEAKERS (OFF/A/B/A+B) is not set to OFF (page 50).
- Press MUTE on the remote to cancel the muting function.
- Check that you have selected the correct component with INPUT SELECTOR.
- Check that headphones are not connected.
- When only a very low-level sound is heard, check to see if Night Mode is activated (page 122).
- The protective device on the receiver has been activated. Turn off the receiver, eliminate the short-circuit problem, and turn on the power again.

There is no sound from a specific component.

- Check that the component is connected correctly to the audio input jacks for that component.
- Check that the cord(s) used for the connection is (are) fully inserted into the jacks on both the receiver and the component.

There is no sound from one of the front speakers.

- Connect a pair of headphones to the PHONES jack to verify that sound is output from the headphones. If only one channel is output from the headphones, the component may not be connected to the receiver correctly. Check that all the cords are fully inserted into the jacks on both the receiver and the component. If both channels are output from the headphones, the front speaker may not be connected to the receiver correctly. Check the connection of the front speaker which is not outputting any sound.
- Make sure you have connected both the L or R jack to an analog component and not just to either the L or R jack. Use a monaural-stereo cable (not supplied). However, there will be no sound from the center speaker when a sound field (Pro Logic, etc.) is selected. When the center speaker is not connected, sound is output only from the front left/right speakers.

There is no sound from analog 2 channel sources.

- Check to make sure the selected audio (digital) input jack is not assigned to other inputs in “Input Assign” in the Input menu (page 118).

There is no sound from digital sources (from COAXIAL or OPTICAL input jack).

- Check that the INPUT MODE is not set to “Analog.”
- Check that the “2ch Analog Direct” is not being used.
- Check to make sure the selected audio (digital) input jack is not assigned to other inputs in “Input Assign” in the Input menu (page 118).

The source sound input from the HDMI IN jack is not output from an amplifier or the TV speaker connected to the receiver.

- Check that the component is connected correctly to the HDMI IN jack for that component.
- Depending on the playback component, component may need to be set up. Refer to the operating instructions supplied with the each component.
- Be sure to use a connecting cable for the HDMI jack corresponding to high speed (an HDMI version 1.3a, category 2 cable) when you view images or listen to sound during a 1080p or Deep Color transmission.

The left and right sounds are unbalanced or reversed.

- Check that the speakers and components are connected correctly and securely.
- Adjust the balance parameters using the Auto Calibration settings menu.

There is severe hum or noise.

- Check that the speakers and components are connected securely.
- Check that the connecting cords are away from a transformer or motor, and at least 3 meters (10 feet) away from a TV set or fluorescent light.
- Move your TV away from the audio components.
- Make sure you have grounded the \perp SIGNAL GND terminal (only when a turntable is connected).
- The plugs and jacks are dirty. Wipe them with a cloth slightly moistened with alcohol.

There is no sound, or only a very low-level sound is heard from the center/surround/surround back speakers.

- Check that the speaker settings are appropriate using the Auto Calibration settings menu or “Speaker Pattern” in the Speaker settings menu. And then check that sound is output from each speaker correctly, using “Test Tone” in the Speaker settings menu.
- Select the “HD-D.C.S.” sound field (page 88).
- Adjust the speaker level (page 131).
- Make sure the center/surround speaker (s) is (are) set to either “SMALL” or “LARGE.”

There is no sound from the surround back speakers.

- Some discs have no Dolby Digital Surround EX flag even though the packages have Dolby Digital Surround EX logos.

There is no sound from the subwoofer.

- Check that the subwoofer is connected correctly and securely.
- Make sure you have turned on your speaker.
- When all speakers are set to “LARGE” and “Neo:6 Cinema,” or “Neo:6 Music” is selected, there is no sound from the subwoofer.

The surround effect cannot be obtained.

- Make sure the sound field function is on (press MOVIE or MUSIC).
- Sound fields do not work when DTS-HD signals with a sampling frequency of 88.2 kHz and higher are being received.
- Sound fields do not work when Dolby TrueHD signals with a sampling frequency of 176.4 kHz and higher are being received.

Dolby Digital or DTS multi-channel sound is not reproduced.

- Check that the DVD, etc. you are playing is recorded in Dolby Digital or DTS format.
- When connecting the DVD player, etc., to the digital input jacks of this receiver, make sure the setting for the digital audio output of the connected component is available.

Recording cannot be carried out.

- Check that the components are connected correctly (page 27).
- Select the source component (page 62).

The MULTI CHANNEL DECODING lamp does not light up in blue.

- Check that the playback component is connected on a digital jack and the input is selected properly on this receiver.
- Check whether the input source of the software being played back corresponds to the multi-channel format.
- Check whether the setup on the playback component is set to multi-channel sound.
- Check to make sure the selected audio (digital) input jack is not assigned to other inputs in “Input Assign” in the Input menu (page 118).

There is no sound from the component connected to the DIGITAL MEDIA PORT adapter.

- Adjust the volume of this receiver.
- The DIGITAL MEDIA PORT adapter and/or component is not connected correctly. Turn off the receiver, then reconnect the DIGITAL MEDIA PORT adapter and/or component.
- Check the DIGITAL MEDIA PORT adapter and/or component device to make sure it supports this receiver.

Video

There is no picture or an unclear picture appears on the TV screen or monitor.

- Select the appropriate input on the receiver (page 62).
- Set your TV to the appropriate input mode.
- Move your TV away from the audio components.
- Assign the component video input correctly.
- The input signal should be same as input when you are up-converting an input signal with this receiver (page 40).

The image of the COMPONENT VIDEO OUT is corrupted.

- Video input signals other than 480p component are not received when signals are output from the VIDEO jack. Input 480i component video signals.
- When component input signals other than 480p are output, use the COMPONENT VIDEO OUT jack and set “Resolution” to “DIRECT.”

Images from the component connected to the HDMI jack are not output to the TV, are distorted, or are interrupted.

- The output of the HDMI video signals of the receiver may be set to “OFF.” In this case, select “HDMI A” or “HDMI B” using the HDMI OUTPUT button (page 116).
- If the compatible video format differs between the monitors connected to the HDMI OUT A jack and the HDMI OUT B jack of the receiver, “HDMI A + B” may not work.
- Depending on the playback component you connect, “HDMI A + B” may not work.
- Make sure that cables are correctly and securely connected to components.
- Depending on the playback component, component may need to be set up. Refer to

the operating instructions supplied with the each component.

- Be sure to use a connecting cable for the HDMI jack corresponding to high speed (an HDMI version 1.3a, category 2 cable) when you view images or listen to sound during a 1080p or Deep Color transmission.
- Images from the component connected to the HDMI jack may be distorted. In this case, set “Video Direct” to “ON” in the HDMI settings menu.
- Images or sound from the component connected to the HDMI jack may be interrupted when video signals are switched. In this case, set “Video Direct” to “ON” in the HDMI settings menu.

Recording cannot be carried out.

- Check that the components are connected correctly (page 32).
- Select the source component (page 62).

The GUI does not appear on the TV screen.

- “GUI MODE” may have been turned off. Press GUI MODE to turn “GUI MODE” on.
- Check the TV is connected correctly.

Images appear later than the associated sound is played when the HDMI input is selected.

- Depending on the component connected to the HDMI jack, or the source played back, images may appear later than the associated sound. In this case, set “Video Direct” to “ON” in the HDMI settings menu.

Tuner

The FM reception is poor.

- Use a 75-ohm coaxial cable (not supplied) to connect the receiver to an outdoor FM antenna (aerial) as shown on page 189. If you connect the receiver to an outdoor antenna (aerial), ground it against lightning. To prevent a gas explosion, do not connect the ground (earth) wire to a gas pipe.

Outdoor FM antenna (aerial)

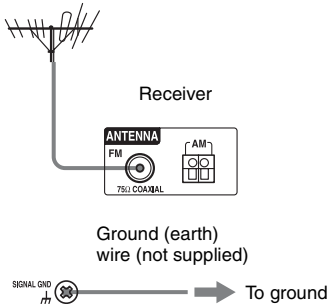

Radio stations cannot be tuned in.

- Check that the antennas (aerials) are connected securely. Adjust the antennas (aerials) and connect an external antenna (aerial), if necessary.
- Keep the satellite radio antenna, away from the speaker cords and the power cord to avoid picking up noise.
- The signal strength of the stations is too weak (when tuning in with automatic tuning). Use direct tuning.
- Make sure you set the tuning interval correctly (when tuning in AM stations with direct tuning).
- No stations have been preset or the preset stations have been cleared (when tuning by scanning preset stations). Preset the stations (page 71).
- Press DISPLAY so that the frequency appears on the display.

The system cannot receive satellite channels at all.

- The receiving condition is not good. Move the antenna to the place where the condition is good.
- Check that you subscribed to the desired satellite radio service (see page 73).

RDS does not work.

- Make sure that you are tuned to an FM RDS station.
- Select a stronger FM station.

The RDS information that you want does not appear.

- Contact the radio station and find out whether or not they actually provide the service in question. If so, the service may be temporarily out of order.

Control for HDMI

The Control for HDMI function does not work.

- Check the HDMI connection (page 33).
- Make sure “Control for HDMI” is set to “ON” in HDMI settings menu.
- Make sure the connected component is compatible with the Control for HDMI function.
- Check the Control for HDMI settings on the connected component. Refer to the operating instructions of the connected component.
- If you change the HDMI connection, connect/disconnect the AC power cord, or there is a power failure, repeat the procedures of “Preparing for the “BRAVIA” Sync” (page 112).
- If you select “HDMI A” or “HDMI A + B,” after you have selected “HDMI B” or “OFF,” the Control for HDMI function may not work properly for a while. This is because the component connected to the HDMI A jack must re-recognize the receiver that is equipped with the Control for HDMI function. If the Control for

HDMI function does not work properly for a long time, perform the steps given in “Preparing for the “BRAVIA” Sync” (page 112).

- When you select “HDMI B” or “OFF,” the Control for HDMI function does not work properly.

No sound is output from the receiver and TV speaker while using the System Audio Control function.

- Make sure the TV is compatible with the System Audio Control function.
- If the TV does not have System Audio Control function, set the “Audio Out” settings in HDMI settings menu to
 - “TV+AMP” if you want to listen to the sound from the TV speaker and receiver.
 - “AMP” if you want to listen to the sound from the receiver.
- When you connect the receiver to a video component (projector, etc.), sound may not be output from the receiver. In this case, select “AMP.”
- You cannot listen to the sound of a component connected to the receiver while a TV is selected as the input on the receiver.
 - Change the input of the receiver to HDMI when you want to watch a program on a component connected to the receiver.
 - Change the TV channel when you want to watch a TV broadcast.
 - Select the component or input you want to watch when you watch a program on the component connected to the TV. Refer to the operating instructions of the TV on this operation.
- When using the Control for HDMI function, you cannot control the connected component using TV’s remote.
 - Depending on the connected component and TV, you may need to set up the component and TV. Refer to the operation instructions supplied with each component and TV.

- Change the input of the receiver to the HDMI input connected to the component.

Remote commander

The remote does not function.

- Point the remote at the remote sensor on the receiver.
- Remove any obstacles in the path between the remote and the receiver.
- Replace all the batteries in the remote with new ones, if they are weak.
- Make sure that the command modes of the receiver and the remote are the same. If the command mode of the receiver and the remote are different, you cannot operate the receiver with the remote (page 124).
- Make sure you select the correct input on the remote.
- When you operate a programmed non-Sony component, the remote may not function properly depending on the model and the maker of the component.

Network

Cannot find the server.

- Check the following:
 - Is the router is turned on?
 - If there is another device between this device and the router, check that device is turned on.
 - Are all of the cables are connected correctly and securely?
 - Is the settings to make sure that they match the router’s settings (DHCP or fixed IP address)?
- When using a computer, check the following:
 - the built-in firewall settings for the computer’s operating system.
 - the firewall settings of your security software. To check the firewall settings of your security software, refer to your security software’s Help section.

- Register this device with the server. For details, refer to the instructions supplied with the server.
- Wait for a few moments, and then try connecting to the server again.

If the trouble is other than the cases above and the trouble is not solved even if you wait for a while, press **I/⏻** on the remote or **POWER** on the receiver to turn the receiver on again.

Error messages

If there is a malfunction, the display shows a code of two numbers and a message. You can check the status of the system by the message. See the following table to solve the problem. If any problem persists, consult your nearest Sony dealer.

PROTECTOR

Irregular current is output to the speakers, or the upper panel of the receiver is covered with something. The receiver will automatically turn off after a few seconds. Check the connection of speakers and turn on the power again.

For other messages, see “Message list after auto calibration measurement” (page 55), “SIRIUS Satellite Radio message list” (page 80), “XM Radio message list” (page 81) and “DIGITAL MEDIA PORT message list” (page 66).

Clearing the memory

Reference sections

To clear	See
All memorized settings	page 47
Multifunction remote commander	page 179

To clear the memory of the simple remote commander

After removing the batteries, do not use the remote for a few minutes.

About support information

Refer to the following web site for details of the latest information on the receiver.

For customers in the United States and Canada:

<http://www.sony.com/essupport>

For the customers in Europe:

<http://support.sony-europe.com/quickjump/STR>

Specifications

AUDIO POWER SPECIFICATIONS

POWER OUTPUT AND TOTAL HARMONIC DISTORTION:

With 8 ohm loads, both channels driven, from 20 – 20,000 Hz; rated 120 watts per channel minimum RMS power, with no more than 0.09% total harmonic distortion from 250 milliwatts to rated output.

Amplifier section

POWER OUTPUT

Rated Power Output at Stereo Mode^{1) 2)}
(8 ohms 20 Hz – 20 kHz,
THD 0.09%):
120 W + 120 W

Reference Power Output at Stereo Mode
(4 ohms 20 Hz – 20 kHz,
THD 0.15%):
120 W + 120 W

Reference Power Output
(8 ohms 1 kHz, THD 0.7%)
FRONT²⁾:
130 W + 130 W
CENTER²⁾: 130 W
SURROUND²⁾:
130 W + 130 W
SURROUND BACK²⁾:
130 W + 130 W

Reference Power Output
(4 ohms 1 kHz, THD 0.7%)
FRONT²⁾:
120 W + 120 W
CENTER²⁾: 120 W
SURROUND²⁾:
120 W + 120 W
SURROUND BACK²⁾:
120 W + 120 W

¹⁾Depending on the sound field settings and the source, there may be no sound output.

²⁾Measured under the following conditions:

Power requirements: 120 V AC, 60 Hz (in USA and Canada), 230 V AC, 50/60 Hz (in Europe and general area)

Frequency response

PHONO	RIAA equalization curve ± 1.0 dB (20 Hz – 20 kHz)
MULTI CHANNEL INPUT, SA-CD/CD, TAPE, MD, TV, VIDEO 1/2, BD, DVD, SAT	10 Hz – 100 kHz ± 3 dB

Inputs (Analog)

PHONO	Sensitivity: 2.5 mV Impedance: 50 kohms S/N: 90 dB (A, 20 kHz LPF)
MULTI CHANNEL INPUT, SA-CD/CD, TAPE, MD, TV, VIDEO 1/2, BD, DVD, SAT	Sensitivity: 150 mV Impedance: 50 kohms S/N: 100 dB (A, 20 kHz LPF)

Inputs (Digital)

BD, DVD, SA-CD/CD (Coaxial)	Impedance: 75 ohms S/N: 96 dB (A, 20 kHz LPF)
VIDEO 1/2, TV, SAT, TAPE, MD (Optical)	S/N: 96 dB (A, 20 kHz LPF)

Outputs

TAPE (REC OUT), MD (REC OUT), VIDEO 1, ZONE 2, ZONE 3 (AUDIO OUT)	Voltage: 150 mV Impedance: 1 kohm
FRONT L/R, CENTER, SURROUND L/R, SURROUND BACK L/R, SUBWOOFER	Voltage: 2 V Impedance: 1 kohm

FM tuner section

Tuning range

Area	Tuning scale	
	10 kHz step	9 kHz step
USA, Canada	530 – 1,710 kHz	531 – 1,710 kHz
Europe	–	531 – 1,602 kHz

Antenna (aerial) FM wire antenna (aerial)

Antenna (aerial) terminals
75 ohms, unbalanced

AM tuner section

Tuning range 531 – 1,602 kHz

Intermediate frequency
450 kHz

Antenna (aerial) Loop antenna (aerial)

Video section

Inputs/Outputs

Video: 1 V_{p-p}, 75 ohms

COMPONENT VIDEO:

Y: 1 V_{p-p}, 75 ohms

P_B/C_B: 0.7 V_{p-p}, 75 ohms

P_R/C_R: 0.7 V_{p-p}, 75 ohms

80 MHz HD Pass Through

HDMI Video

Input/Output (HDMI Repeater block)

640 × 480p@60 Hz

720 × 480p@59.94/60 Hz

1280 × 720p@59.94/60 Hz

1920 × 1080i@59.94/60 Hz

1920 × 1080p@59.94/60 Hz

720 × 576p@50 Hz

1280 × 720p@50 Hz

1920 × 1080i@50 Hz

1920 × 1080p@50 Hz

1920 × 1080p@24 Hz

Supported playback formats

Content delivered from the device on the home network needs to support the following formats for you to play back content on this receiver.

Type of content	Format	Other conditions
Video	MPEG-2 PS	DLNA guidelines 1.0 compliant Maximum resolution 720 × 480 MPEG-2 System (up to 10 Mbps) mixed with MPEG-1 Layer 1/2/3, PCM, or AC3 audio format
	Windows Media Video (WMV)	Maximum resolution 720 × 480 Windows Media Video 7/8/9 standard definition (up to 2 Mbps for Main profile) mixed with Windows Media Audio 7/8/9 excludes all profile of Windows Media Audio professional
Music	Linear PCM	LPCM defined in DLNA guidelines 1.0
	MPEG-1 Layer3 (MP3)	DLNA guidelines 1.0 compliant
	Windows Media Audio (WMA)	DLNA guidelines 1.0 compliant Excludes all profile of Windows Media Audio professional
	AAC	AAC_ISO defined in DLNA guidelines 1.0
Photo	JPEG	DLNA guidelines 1.0 compliant Number of pixels must be up to 4096 × 4096 (horizontal pixels × vertical pixels).
	BMP*	
	PNG*	

* As BMP and PNG are not defined in DLNA guidelines 1.0, image files in those formats may not be played back properly, depending on the connected server or the files.

General

Power requirements 120 V AC, 60 Hz
(in USA and Canada)
230 V AC, 50/60 Hz
(in Europe and general
area)

Power output (DIGITAL MEDIA PORT)
DC OUT: 5 V, 700 mA

Power consumption

Area	
USA and Canada	480 W
Europe	480 W

Power consumption (during standby mode)
0.9 W (when “Control for
HDMI” and “Installer
Mode” are set to “OFF,”
and the power for zone 2/
zone 3 is turned off.)

Dimensions 430 × 175 × 430 mm
(17 × 6 ⁷/₈ × 17 inches)
(width/height/depth)
including projecting parts
and controls

Mass (Approx.) 16.8 kg (36 lb 13 oz)

- Standby power consumption 0.9 W.
- Halogenated flame retardants are not used in the printed wiring boards.

Supplied accessories

Operating Instructions (this manual)

Quick Setup Guide (1)

GUI Menu List (1)

Software License Information (1)

Optimizer microphone ECM-AC1 (1)

FM wire antenna (aerial) (1)

AM loop antenna (aerial) (1)

AC power cord (mains lead) (1)

Multifunction remote commander (1)

Simple remote commander (1)

R6 (size-AA) batteries (4)

IR Blaster (1)

ES Utility CD-ROM (1)

VAIO Media plus CD-ROM (1)

Design and specifications are subject to
change without notice.

Index

Symbols

⌚ SIGNAL GND terminal 31

Numerics

2 channel 82
 24p Auto Sound Sync 143
 2ch Analog Direct 82
 2ch Stereo Mode 82
 4 Ω 49
 5.1 channel 21
 7.1 channel 21
 8 Ω 49

A

A.F.D. (mode) 83
 A/V Sync 63, 138, 151
 AC power cord 47
 Account 98
 AM 68
 Antenna Aiming 75
 Audio 138
 AUDIO OUT 152
 Audio Out 142
 Auto Calibration 50, 128, 149
 Auto Tuning 68

B

Bass 9, 136, 151
 BI-AMP 130
 Bi-amplifier connection 126
 Blu-ray Disc Player 34, 37, 62

C

Calibration Type Select 54, 149
 Category Mode 75
 CD player 28, 31
 Center Mix 130, 150
 Changing the display 152
 Clear
 memory 47
 remote 179
 Connections
 antennas 44

audio components 27
 monitor 25
 Network 45
 speakers 23
 video components 32

Control for HDMI 142
 Crossover Freq 132, 150

D

D. Range Comp (Dynamic range compressor)
 133, 149
 DCAC (Digital Cinema Auto Calibration) 50
 Decode Priority 139, 151
 Digital Legato Linear (D.L.L.) 138
 DIGITAL MEDIA PORT 15, 17, 28, 64
 Direct Tuning 69, 76
 Display 11
 Distance Unit 134, 150
 DLNA 92
 DMPort Control 67
 Dolby Digital EX 90
 DTS Neo:6 (Cinema, Music) 84
 Dual Mono 139, 151
 DVD player 34, 37
 DVD recorder 39

E

Effect Type 134, 151
 EQ 136
 ES Utility 103

F

Favorite stations 102
 FM 68
 FM Mode 68, 151

G

GUI (Graphical User Interface) 25

H

H.A.T.S. 142
 HD-D.C.S. 88
 HD-D.C.S. (Effect Type) 134

HDMI 142
HDMI AUTO DETECT 114
HDMI IN button 9, 47
HDMI jacks 15, 33
HDMI OUT button 9, 116

I

Input 62
Input Assign 63, 118
INPUT MODE 117
Installer Mode 146, 152
iPod 66, 67

L

L.F.E. (Low Frequency Effect) 13
LARGE 131
Level 136
Listening 101
Lock Code 79, 151

M

MASTER VOLUME 10
Menu 60, 127
Messages
 Auto Calibration 55
 DIGITAL MEDIA PORT 66
 Error 191
 SIRIUS 80
 XM 81
Movie 88
Multi Zone 105, 136
Music 64, 86
Music Guide 99
Muting 63
My Library 100, 101

N

Name Input 63, 72, 129
Network settings
 Check 144
Neural-THX 84
Night Mode 122, 139, 151

O

Option menu 61

P

Parental Lock 78, 151
Party Mode 110
Pass Through 116, 142
Phase Audio 133, 149
Phase Noise 132, 149
PHONES 9
PIP (Picture in Picture) 20
Position (Auto Calibration) 128, 149
Preset channels 77
Preset Mode 78
Preset stations 71
Pro Logic II 84
Pro Logic IIx 84
PROTECTOR 191

Q

Quick Click 153
Quick Setup 52

R

Radio ID 75
Recording 123
Remote 17–20, 48, 170–179
Repeat 66, 97
Resetting 47
Resolution 140, 151
Rhapsody
 Account 98
 Music Guide 99
 My Library 100, 101
 Rhapsody Channels 99
 Rhapsody Digital Music Service 98
 Search 100
Rhapsody Channels 99
Rhapsody Digital Music Service 98

S

Satellite radio 73
Screen Saver 146
Search 100
Server
 Preparing 58
Setting menu 127
Settings 127
SHOUTcast
 Favorite stations 102

Listening 101
Shuffle 66, 97
SIRIUS 73
SIRIUS Satellite Radio 73
Sleep timer 121
SMALL 131
Sound Field 63
Speaker 130
Speaker Impedance 48, 150
Speaker Pattern 130, 150
SPEAKERS (OFF/A/B/A+B) 9, 50
Subwoofer Level 143, 152
Super Audio CD player 28, 30, 31
Sur Settings 151
Surround 84, 134
System 146

T

Test Tone 132, 149
TONE 9
TONE MODE 9, 47
Treble 9, 136, 151
Tuner 68
Tuning 68, 69, 71

U

Up converting 40

V

VCR 39
Video 64, 140
VIDEO 2 IN jacks 40

X

XM 73
XM Radio 73

Z

Zone 12V Trigger 137, 152
ZONE 2 130

